



Advanced Technology Video

USER MANUAL

DVR Models:

VLD904

VLD908

VLD916

**Real Time 960H, H.264
Digital Video Recorders**

Contents

- About this Manual5
- FCC Compliance Statement.....5
- Copyright5
- Safety Information6
- Chapter 1: Product Overview7**
 - 1.1 Features7
 - 1.2 Accessories7
 - 4-Channel / 8-Channel DVR7
 - 16-Channel DVR8
 - 1.3 Parts and Functions9
 - 1.3.1 Front Panel9
 - 4-Channel DVR9
 - 8-Channel DVR10
 - 16-Channel DVR11
 - 1.3.2 Rear Panel.....12
 - 4-Channel DVR12
 - 8-Channel DVR12
 - 16-Channel DVR13
 - 1.4 Mouse13
 - 1.5 Remote Control.....14
 - 4-Channel / 8-Channel DVR14
 - 16-Channel DVR15
- Chapter 2: Installation 16**
 - 2.1 Installing the Hard Disk Drive.....16
 - 2.1.1 Installing HDD on 4-Channel / 8-Channel DVR16
 - 2.1.2 Installing HDD on 16-Channel DVR17
 - 2.2 Connecting the Power18
 - 2.3 Connecting to Monitors18
 - 2.3.1 BNC Connection18
 - 2.3.2 VGA Connection19
 - 2.3.3 HDMI Connection19
 - 2.4 Connecting the Cameras20
 - 2.4.1 BNC Connection20
 - 2.4.2 RS-485 Connection21
 - 2.5 Connecting the Alarm21
 - 2.6 Connecting the Sensors22
 - 2.7 Connecting the Microphones22
 - 2.7.1 RCA Connection22
 - 2.8 Connecting to Network.....23
 - 2.9 Connecting to Other Devices23
 - 2.10 Connecting to Speakers24
 - 2.10.1 RCA Connection24
 - 2.11 Connecting the KeyBoard.....24
- Chapter 3: Getting Started 25**
 - 3.1 Starting Up25
 - 3.2 Set Startup Wizard25
 - 3.3 Shutting Down27

3.4 The Main Screen	29
3.4.1 Screen Icons	29
3.4.2 Virtual Keyboard.....	30
3.4.3 Locking the Screen	30
3.4.4 Pop-up Menu.....	31
3.4.5 On Screen Display (OSD) menu	32
3.5 Screen Modes	33
3.5.1 Live View	33
3.5.2 Split Mode	34
3.5.3 Picture-in-Picture (PIP) Mode.....	34
3.5.4 SEQ View	35
3.6 Using PTZ Controls	36
3.6.1 Cruise Mode	37
3.7 Zoom.....	37
3.8 Manual Recording.....	38
Chapter 4: Using the DVR	39
4.1 Setting the Display	39
4.1.1 Live Settings.....	39
4.1.2 Output Settings.....	40
4.1.3 Privacy Zone Settings.....	41
4.2 Record Setup.....	42
4.2.1 Record Parameter.....	42
4.2.2 Schedule Recording	43
4.2.3 Main stream.....	44
4.3 Searching Videos.....	45
4.3.1 Searching and Playing Videos	45
4.3.2 Trimming Videos.....	47
Replaying Videos by Recording Date and Time	48
4.3.3 Searching Videos by Event.....	49
4.3.4 Backing up Videos	50
4.3.5 Viewing and Exporting Log	51
4.4 Setting the Network.....	52
4.4.1 Network Settings	52
4.4.2 Remote Stream Setup	54
4.4.3 Email Settings	54
Email Schedule Setup.....	55
4.4.4 DDNS Settings.....	56
4.5 System Settings	57
4.5.1 Storage Device Setup.....	57
Setting HDD.....	57
Formatting HDD	57
Formatting USB drive	58
4.5.2 PTZ Setup.....	58
4.5.3 Serial Setup	59
4.5.4 General Settings	59
Synchronizing Time with NTP Server	60
Setting Daylight Saving Time	60
4.5.5 User and Password Settings.....	61
Changing the Password	61
Configuring Other Users.....	62

Authorizing Other Users	63
4.5.6 View System Info	64
4.6.6 P2P Connect	64
4.6 Advanced Settings.....	66
4.6.1 Motion Detection Alarm Settings	66
Set Motion Detection Area	67
4.6.2 Other Alarm Settings	67
4.6.3 Maintenance Settings.....	68
Manual Reboot and Power Off	68
Disable Startup Wizard	69
Set Auto Reboot	70
Update System Firmware.....	70
Load Default Settings	70
Save System Settings	71
Load System Settings.....	71
4.6.4 Events Settings.....	72
Chapter 5: Troubleshooting & FAQ	73
5.1 Troubleshooting.....	73
5.2 Frequently Asked Questions	74
Appendix: Specifications.....	75

About this Manual

The material in this document is for information purpose and is subject to change without prior notice. We made every effort to ensure that this user's manual is accurate and complete. However, no liability is assumed for any errors and omissions that may have occurred.

FCC Compliance Statement

This equipment has been tested and found to comply with the limits for a Class B digital device, pursuant to Part 15 of the FCC Rules. These limits are designed to provide reasonable protection against harmful interference in a residential installation. This equipment generates uses and can radiate radio frequency energy and, if not installed and used in accordance with the instructions, may cause harmful interference to radio communications. However, there is no guarantee that interference will not occur in a particular installation. If this equipment does cause harmful interference to radio or television reception, which can be determined by turning the equipment off and on, the user is encouraged to try to correct the interference by one or more of the following measures:

- Reorient or relocate the receiving antenna.
- Increase the separation between the product and receiver.
- Connect the product into an outlet on a circuit different from that to which the receiver is connected.
- Consult the dealer or an experienced radio/TV technician for help.

Declaration of Conformity

This device complies with part 15 of the FCC Rules. Operation is subject to the following two conditions:

1. This device may not cause harmful interference.
2. This device must accept any interference received, including interference that may cause undesired operation.

Copyright

Limitation of Liability

- This publication is provided "AS IS" without warranty of any kind, either expressed or implied, including but not limited to, the implied warranties of merchantability, fitness for any particular purpose, or non-infringement of a third party's rights.
- This publication may include technical inaccuracies or typographical errors. Changes may be made to the information herein, at any time, for publication improvements and/or of the corresponding device(s).

Disclaimer of Warranty

In no event shall the supplier be liable to any party or any person, except for replacement or reasonable maintenance of the product, for the cases, including but not limited to the following:

- Any damage or loss, including but without limitation, direct or indirect, special, consequential or exemplary, arising out of or relating to the device;
- Personal injury or any damage caused by inappropriate use or negligent operation of the user;
- Unauthorized disassemble, repair or modification of the device by the user;
- Any problem, consequential inconvenience, or loss or damage, arising out of combining the system with the devices of a third party;
- Any claim or action for damages, brought by any person or organization being a photogenic subject, due to violation of privacy with the result of pictures from a surveillance camera, including saved data, for some reason, becomes public or is used for the purpose other than for surveillance.

Safety Information



Warning

This is the symbol for indicating any potential hazard, risk or condition requiring special attention. The user needs to refer to the important operating and maintenance or servicing instructions.



Caution

The lightning flash with an arrow head symbol, in an equilateral triangle, is intended to alert the user. There is dangerous "voltage" presence near by the product's enclosure which may be risk of person.

Safety Precautions

- **Do not touch live electrical parts.**
Electric shock can be avoided. Follow the recommended practices listed below. Faulty installation, improper grounding, and incorrect operation and maintenance of electrical equipment are always sources of danger.
- **Do not try to install equipment outdoor, during strong wind and rain.**
- **Do not install or remove equipment outdoor, when raining.**
- **Do not try to install or operate any equipment, during a thunderstorm.**
- **Always ground all electrical equipment and the work platform.**
Prevent accidental electrical shocks. Connect power source, control cabinets, and work platform to an approved electrical ground.
- **Always use the correct cable size.**
Sustained overloading will cause cable failure and result in possible electrical shock or fire hazard. Work cable should be the same rating as the factory.
- **Always keep cables and connectors in good condition.**
Improper or worn electrical connections can cause short circuits and can increase the chance of an electrical shock. Do not use worn, damaged, or bare cables.
- **Always avoid open-circuit voltage.**
The added voltages increase the severity of electric shock hazard.
- **Always wear insulated gloves while you adjust equipment.**
Electric power should be turned off and insulated gloves should be worn when making any equipment adjustment to assure shock protection.
- **Always wear protective clothing such as long sleeve shirts while you are installing or removing equipment.**
- **Always wear high, snug fitting shoes.**
- **Always wear clean clothes without grease or oil.**
- **Protect neighboring workers from exposure to arc radiation.**
- **Always wear long trousers or jeans while you are installing or removing equipment.**
- **Always wear safety helmet or hard head and safety shoes before work.**
- **Always keep the equipment in dry places.**
- **Always wear safety harnesses/belt while you work in high places.**
- **Always wear dry clothing and avoid moisture and water.**
- **Always wear Public Safety Vest, while you work at night.**
- **Make sure all electrical connections are tight, clean, and dry.**
- **Make sure that you are well insulated to eliminate electric static charge.**
- **Always wear dry gloves, rubber-soled shoes, or stand on a dry board or platform.**
- **Always follow recognized safety standards.**
- **Always wear correct eye, ear, and body protection.**
- **Always have second person on-site, while you work in dark, poor ventilation, or high places.**
- **Make sure that you are well protected against arc flashes, mechanical injury, or other mishaps.**
- **Make sure that the polarity of wire is correct before installing equipment.**
- **Always handle equipment with care.**
- **Do not block the ventilation of equipment.**
- **Do not put the magnetic parts around the equipment.**
- **Do not put the objects on top of the equipment.**

Chapter 1: Product Overview

1.1 Features



This device supports the following features:

- H.264 compression technology
- Advanced and friendly user interface with USB mouse control
- Supports simultaneous multi-channel playback with IE browser of videos recorded in different time frames
- Total online surveillance via IE/Safari browser for remote video & audio live view, playback, setup, backup and filing
- Built-in RS-485 port for PTZ control
- Pre-recording feature that allows additional images to be captured prior to the motion detected event
- Instant E-mail notification for alarm-triggered events
- Supports clock synchronization with NTP
- Privacy masks for private area protection (max. 4 areas per channel)
- Free downloadable App "ATV Sky Mobile" for remote monitoring and control via iPhone, iPad and Android hand-held devices
- USB 2.0 interface for easy backup
- Support D1/960H recording and playback
- Viewable on widescreen LCD
- Real-time live display up to 16 cameras with 1920x1080 output resolution
- User Authorization and Authentication Management



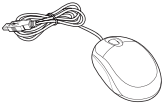
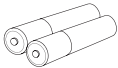

1.2 Accessories

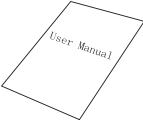
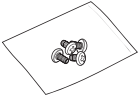
The following items come with your package. If any of them is missing or damaged, please contact your retailer.

4-Channel / 8-Channel DVR

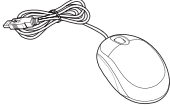
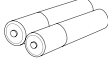
 <p>Remote Control</p>	 <p>Mouse</p>	 <p>Batteries</p>	 <p>CD-ROM</p>	 <p>Power Adapter</p>
 <p>User Manual</p>	 <p>HDD Screw Kit</p>			

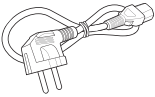
16-Channel DVR

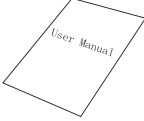
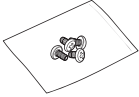
 <p>Remote Control</p>	 <p>Mouse</p>	 <p>Batteries</p>	 <p>CD-ROM</p>
 <p>Power Cord</p>	 <p>Power Adapter</p>	 <p>User Manual</p>	 <p>HDD Screw Kit</p>

1.3 Parts and Functions

1.3.1 Front Panel

4-Channel DVR

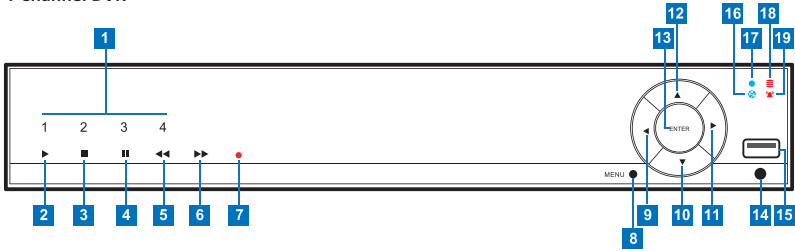

No.	Item	Icon	Description
1	Channel 1-4	CH	Press to display Channel 1-4 in full screen.
2	Play	▶	Press to enter Playback mode or play recorded videos.
3	Stop	■	Press to stop the video playback or stop manual recording.
4	Pause		Press to pause the video playback or enter the frame-playback mode.
5	Rewind	◀◀	During video playback, press to rewind the video.
6	Fast Forward	▶▶	During video playback, press to fast forward the video.
7	Record	●	Press to start manual recording.
8	Menu	Menu	Press to enter or exit the OSD menu.
9	Arrow Left	◀	Press to move left in the OSD menu.
10	Arrow Down	▼	Press to move down in the OSD menu.
11	Arrow Right	▶	Press to move right in the OSD menu.
12	Arrow Up	▲	Press to move up in the OSD menu.
13	Enter	-	In menu options, press to enter the selected menu item and edit the setting.
14	IR remote window	●	Remote control toward this window, you can control the DVR.
15	USB port	-	Connects to a USB mouse, flash disk, and other external storage drive.
16	NET	🌐	Lights blue to indicate the net is working
17	PWR	●	Lights blue to indicate the power is turned on.
18	HDD	🌀	Lights red when the HDD is being accessed.
19	ALM	🚨	Lights red to indicate the DVR record mode is motion or alarm.

8-Channel DVR

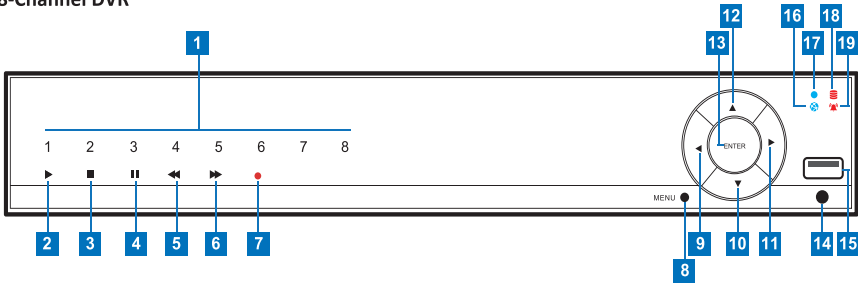

No.	Item	Icon	Description
1	Channel 1-8	CH	Press to display Channel 1-8 in full screen.
2	Play	▶	Press to enter Playback mode or play recorded videos.
3	Stop	■	Press to stop the video playback or stop manual recording.
4	Pause		Press to pause the video playback or enter the frame-playback mode.
5	Rewind	◀◀	During video playback, press to rewind the video.
6	Fast Forward	▶▶	During video playback, press to fast forward the video.
7	Record	●	Press to start manual recording.
8	Menu	Menu	Press to enter or exit the OSD menu.
9	Arrow Left	◀	Press to move left in the OSD menu.
10	Arrow Down	▼	Press to move down in the OSD menu.
11	Arrow Right	▶	Press to move right in the OSD menu.
12	Arrow Up	▲	Press to move up in the OSD menu.
13	Enter	-	In menu options, press to enter the selected menu item and edit the setting.
14	IR remote window	●	Remote control toward this window, you can control the DVR.
15	USB port	-	Connects to a USB mouse, flash disk, and other external storage drive.
16	NET	🌐	Lights blue to indicate the net is working
17	PWR	●	Lights blue to indicate the power is turned on.
18	HDD	📀	Lights red when the HDD is being accessed.
19	ALM	🔔	Lights red to indicate the DVR record mode is motion or alarm.

16-Channel DVR

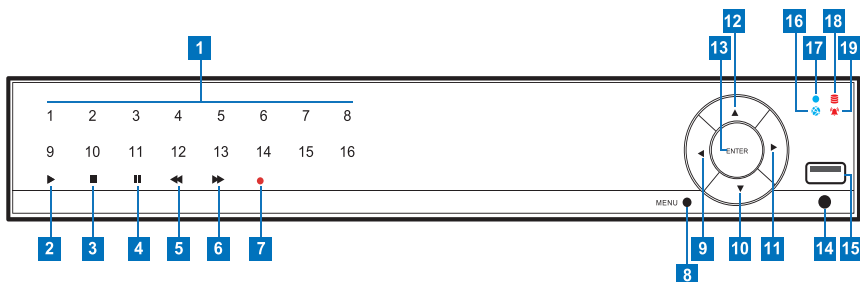

No.	Item	Icon	Description
1	Channel 1-16	CH	Press to display Channel 1-16 in full screen.
2	Play	▶	Press to enter Playback mode or play recorded videos.
3	Stop	■	Press to stop the video playback or stop manual recording.
4	Pause		Press to pause the video playback or enter the frame-playback mode.
5	Rewind	◀◀	During video playback, press to rewind the video.
6	Fast Forward	▶▶	During video playback, press to fast forward the video.
7	Record	●	Press to start manual recording.
8	Menu	Menu	Press to enter or exit the OSD menu.
9	Arrow Left	◀	Press to move left in the OSD menu.
10	Arrow Down	▼	Press to move down in the OSD menu.
11	Arrow Right	▶	Press to move right in the OSD menu.
12	Arrow Up	▲	Press to move up in the OSD menu.
13	Enter	-	In menu options, press to enter the selected menu item and edit the setting.
14	IR remote window	●	Remote control toward this window, you can control the DVR.
15	USB port	-	Connects to a USB mouse, flash disk, and other external storage drive.
16	NET	🌐	Lights blue to indicate the net is working
17	PWR	●	Lights blue to indicate the power is turned on.
18	HDD	📀	Lights red when the HDD is being accessed.
19	ALM	🚨	Lights red to indicate the DVR record mode is motion or alarm.

1.3.2 Rear Panel

4-Channel DVR

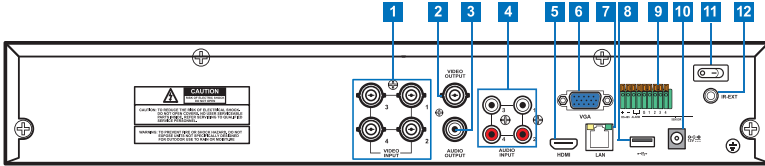

8-Channel DVR

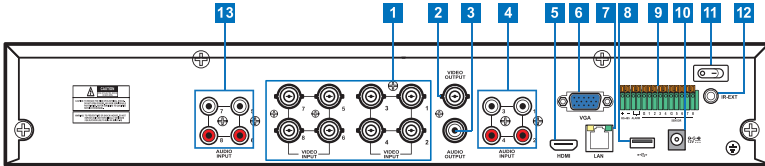

No.	Connector	Description
1	Video input	8-Channel DVR: Connects to a maximum of 8 video input devices (BNC). 4-Channel DVR: Connects to a maximum of 4 video input devices (BNC).
2	Video output	Connects to a video output device via BNC.
3	Audio output	Connects to an audio output device via RCA.
4	Audio input	Connects to CH1-CH4 audio input devices via RCA.
5	HDMI output	Connects to a monitor output via HDMI.
6	VGA output	Connects to a VGA monitor.
7	LAN	Connects to LAN via RJ-45.
8	USB port	Connects to a USB mouse, flash disk, and other external storage drive.
9	RS-485+SENSOR I/O	Connects to a Speed dome camera, sensor or alarm device via RS-485.
10	Power	Connects to the power adapter.
11	Power switch	Press to turn the DVR on or off.
12	IR-EXT port	Connects to an IR extender device.
13	Audio input	Connects to CH5-CH8 audio input devices via RCA.

16-Channel DVR

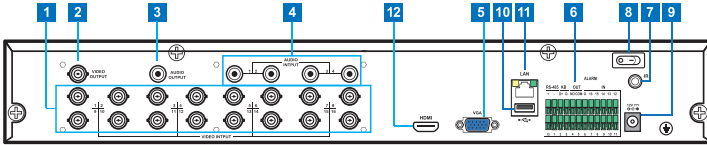

No.	Connector	Description
1	Video input	Connects to a maximum of 16 video input devices via BNC.
2	Video output	Connects to a video output device via BNC.
3	Audio output	Connects to an audio output device via RCA.
4	Audio input	Connects to a maximum of 4 audio input devices via RCA.
5	VGA output	Connects to a VGA monitor.
6	RS-485+SENSOR I/O	Connects to a Speed dome camera, sensor or alarm device via RS-485.
7	IR-EXT port	Connects to an IR extender device.
8	Power switch	Press to turn the DVR on or off.
9	Power	Connects to the power adapter.
10	USB port	Connects to a USB mouse, flash disk, and other external storage drive.
11	LAN	Connects to LAN via RJ-45.
12	HDMI output	Connects to a monitor output via HDMI.

1.4 Mouse

The DVR is supplied with a USB mouse that you can use to operate the DVR. Simply plug in the supplied mouse into the USB mouse connector at the rear panel of the device.

Mouse Operation	Description
Left-click	In OSD menu, click the left button to select and edit the setting.
Right-click	In preview mode, click the right button to display the pop-up menu.
	In main menu or sub menu mode, click the right button to exit the current menu.
Double-click the Left button	Double-click the live image of any channel for full screen display. Double-click the left button again to return to the window-display of all cameras.
Drag an area/line	In motion mode, use this function to select motion area.
	In [Color Setup] menu mode, it will adjust color control bar.

1.5 Remote Control

4-Channel / 8-Channel DVR

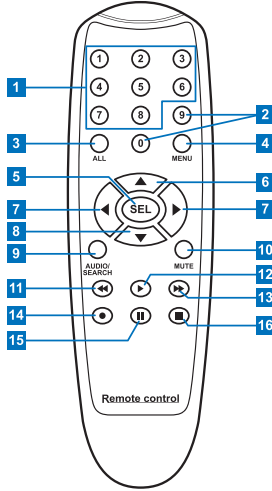

No.	Icon	Description
1	1 ~ 8	Numeric keys Press to display channel 1 ~ 8.
2	9, 0	Numeric keys Press "0" key to lock or unlock the current screen.
3	ALL	Press to display all channels.
4	MENU	Press to enter or exit the Main Menu.
5	SEL	Press to enter the selected menu item and edit the setting.
6	▲	Press to move up in the OSD menu.
7	◀ ▶	Press to move left or right in the OSD menu.
8	▼	Press to move down in the OSD menu.
9	Audio/ Search	In Playback mode, press to turn the audio on or off. Press to search for recorded video.
10	Mute	Press to turn mute on or off.
11	◀◀	Press to rewind during video playback.
12	▶	Press to play recorded video or enter the recording search menu.
13	▶▶	Press to fast forward during video playback.
14	●	Press to start manual recording.
15		Press to pause the video playback or enter frame-playback mode.
16	■	Press to stop manual recording or stop the video playback.

16-Channel DVR

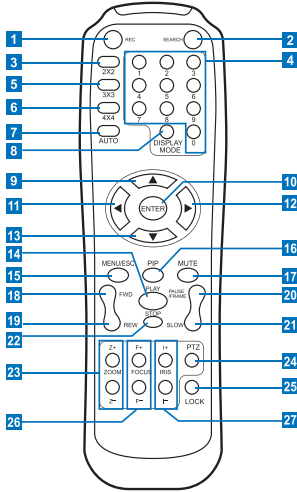

No.	Icon	Description
1		Press to start manual recording.
2	SEARCH	Press to enter search mode.
3	2X2	Press to view a 2x2 channel display.
4	0-9	Numeric keys Press to display the channel in full screen. Press "0" key to lock or unlock the current screen.
5	3X3	Press to view a 3x3 channel display.
6	4X4	Press to view a 4x4 channel display.
7	AUTO	Press to enable auto SEQ mode.
8	DISPLAY MODE	Press to toggle multi-window display (4-CH, 9-CH, 16-CH, Full Screen)
9		Press to move up in the OSD menu.
10	ENTER	Press to enter the selected menu item and edit the setting.
11		Press to move left in the OSD menu.
12		Press to move right in the OSD menu.
13		Press to move down in the OSD menu.

No.	Icon	Description
14	PLAY	Press to play recorded video.
15	MENU/ESC	Press to enter or exit the Main Menu.
16	PIP	Press to enter Picture-in-Picture (PIP) mode.
17	MUTE	Press to mute audio or disable mute.
18	FWD	Press to fast forward video playback (x2, x4, x8).
19	REW	Press to rewind video playback (x2, x4, x8).
20	PAUSE/FRAME	Press to pause video playback or enter frame-playback mode.
21	SLOW	Press to playback video in slow motion (1/2, 1/4, 1/8).
22	STOP	Press to stop video playback.
23	ZOOM	Press Z+ to zoom in or Z- to zoom out display.
24	PTZ	Press to configure PTZ settings.
25	LOCK	Press to lock the system.
26	FOCUS	Press F+ or F- to adjust focus.
27	IRIS	Press I+ or I- to adjust aperture.

Chapter 2: Installation

2.1 Installing the Hard Disk Drive

Depending on the package you have purchased, the hard disk drive may be included in the full package. If it is not pre-installed, follow the installation instructions on this user manual.



DO NOT install or remove the hard disk drive while the device power is turned on.

2.1.1 Installing HDD on 4-Channel / 8-Channel DVR

The 4-channel / 8-channel DVR supports one 3.5" SATA hard disk drive. To install the HDD, follow the steps below.

Note:

The illustrations below show an 8-channel DVR, same procedures apply to a 4-channel DVR.

- 1** Loosen the screws in the left, right, and rear sides as shown.

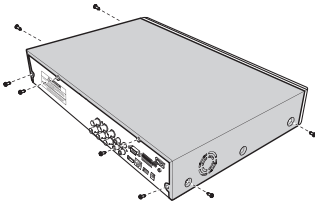

- 2** Push back then lift up the cover to remove it.

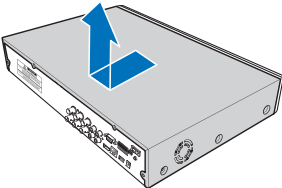

- 3** Connect the data and power cables to the hard disk drive (HDD) and place the HDD on the DVR case.

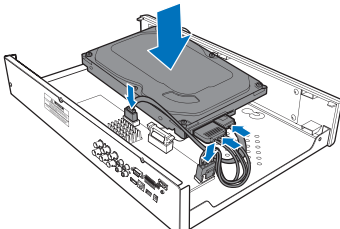

- 4** Align the HDD to the holes on the DVR case and secure the HDD using the four (4) supplied screws.

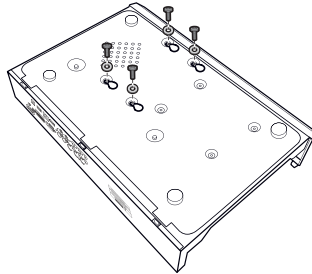

- 5** Attach the cover and the screws back in place.

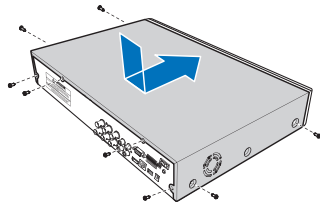

2.1.2 Installing HDD on 16-Channel DVR

The 16-channel DVR supports up to two 3.5" SATA hard disk drives. To install the HDD, follow the steps below.

1 Loosen the screws on the left, right, and rear sides as shown.

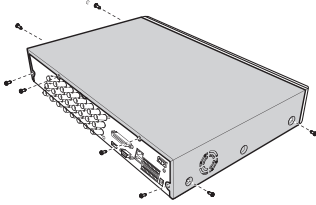

2 Push back then lift up the cover to remove it.

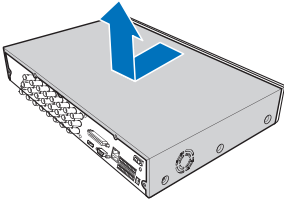

3 Detach the screws to remove the HDD bracket.

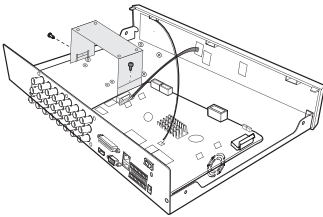

4 Attach the HDD to the bracket using the four (4) supplied screws (1# HDD).

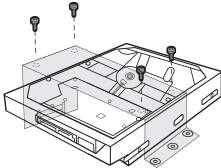

5 Attach the DVR back to the compartment using four (4) screws (2# HDD).

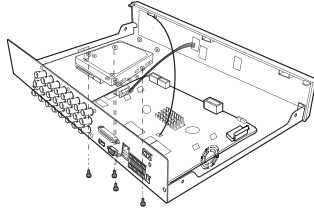

6 Connect the data cables to the hard disk drive (HDD).

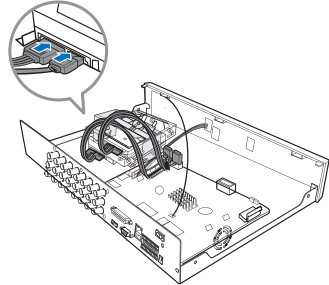

7 Connect the power cables to the hard disk drive (HDD) and the DVR.

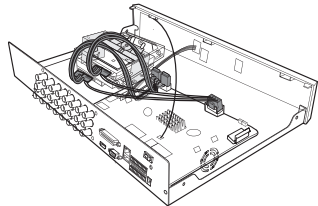

8 Attach the cover and screws back in place.

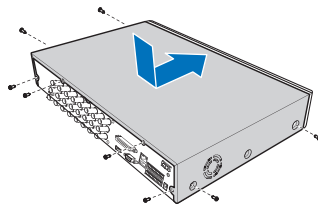

2.2 Connecting the Power

Use only the supplied power adapter that came with the DVR.

- 1 Connect one end of the power adapter to the power connector on the back of the DVR.
- 2 Plug the other end of the power adapter into the wall outlet.
- 3 Press the power switch to turn on the power.

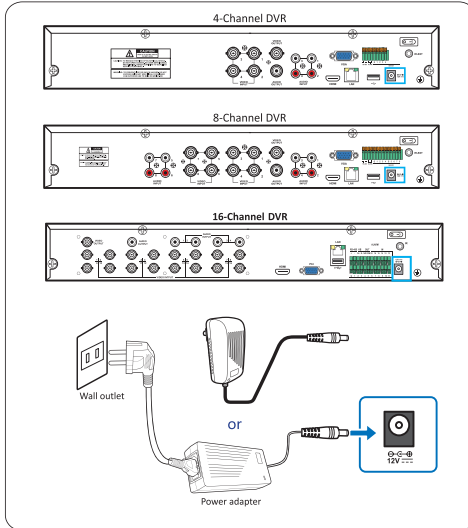
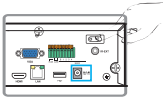

2.3 Connecting to Monitors

The preview screen can be displayed on monitors via BNC, VGA, or HDMI connection.

2.3.1 BNC Connection

Connect the video output of the DVR to the monitor via BNC connector as shown.

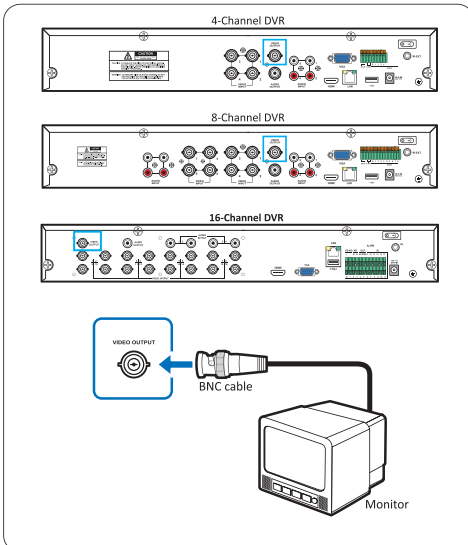

2.3.2 VGA Connection

Connect the video output of the DVR to the monitor via VGA connector as shown.

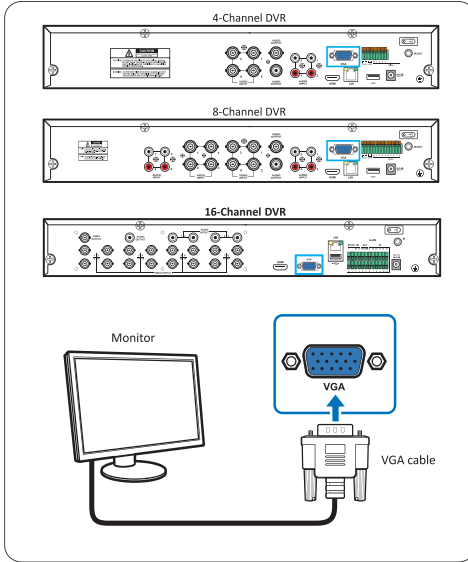

2.3.3 HDMI Connection

Connect the video output of the DVR to the monitor via HDMI connector as shown.

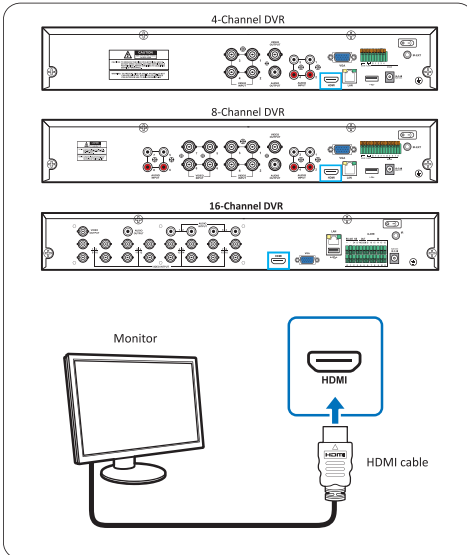

2.4 Connecting the Cameras

Connect the camera cable(s) to the video input of the DVR via BNC or RS-485 connection.

2.4.1 BNC Connection

Connect the camera cable(s) to the video input of the DVR via BNC connector as shown.

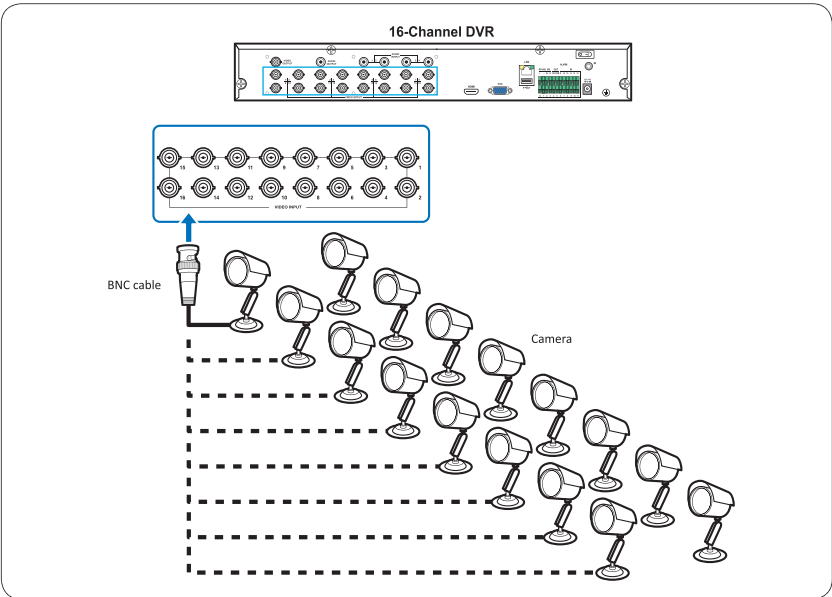
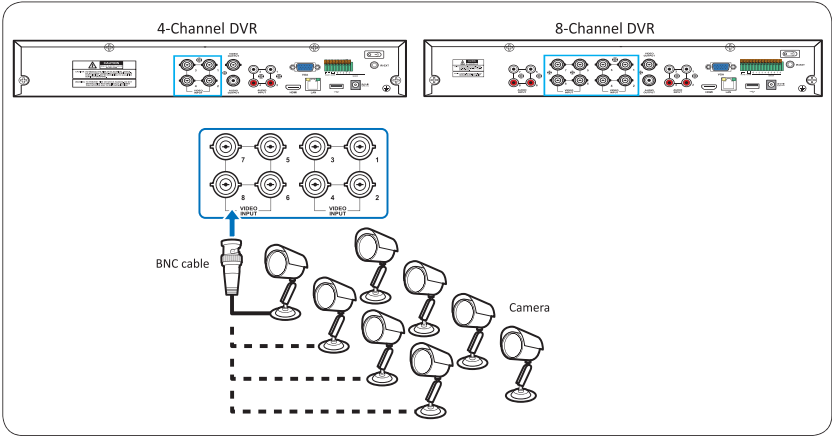

2.4.2 RS-485 Connection

If you are using a PTZ speed dome, connect the camera cable to the video input of the DVR via RS-485 connector as shown.

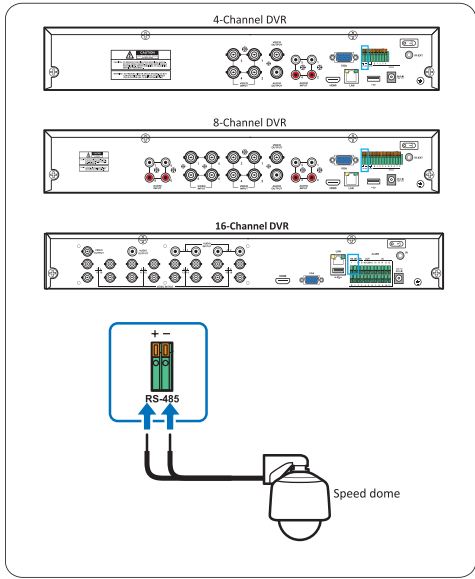

2.5 Connecting the Alarm

You can connect one alarm device via RS-485 connection as shown.

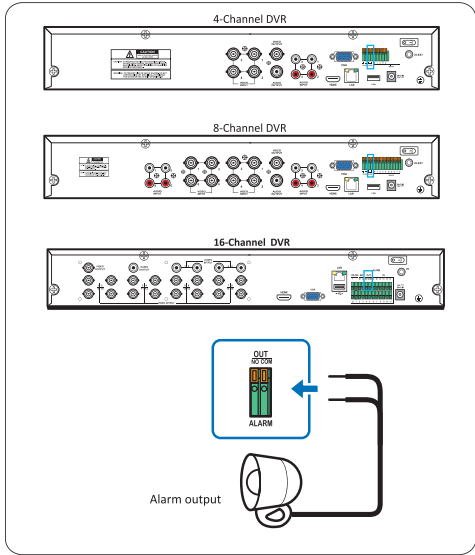

2.6 Connecting the Sensors

You can connect sensors up to channels. The connectors are labelled according to channels.

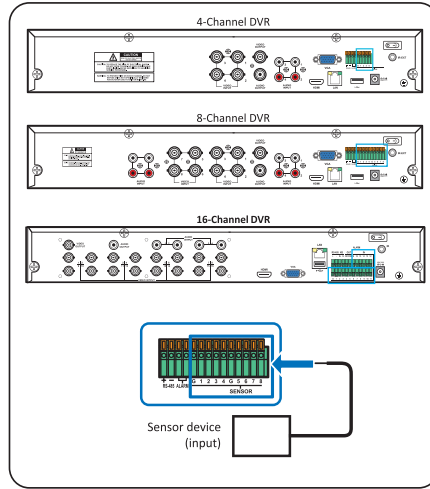

2.7 Connecting the Microphones

The DVR supports up to 4 audio input channels. Microphones can be connected directly via RCA connection.

2.7.1 RCA Connection

Connect the microphone(s) using RCA cable connection as shown.

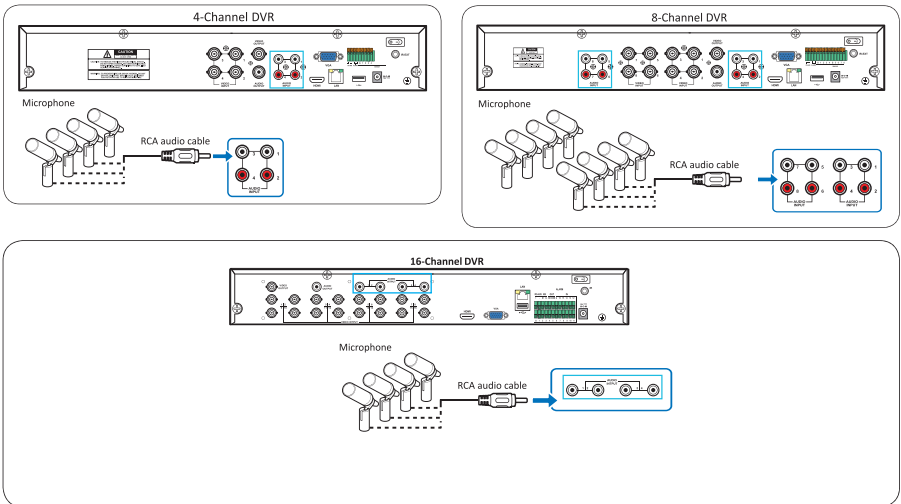

2.8 Connecting to Network

For remote monitoring, connect the DVR to the internet via wired network connection.

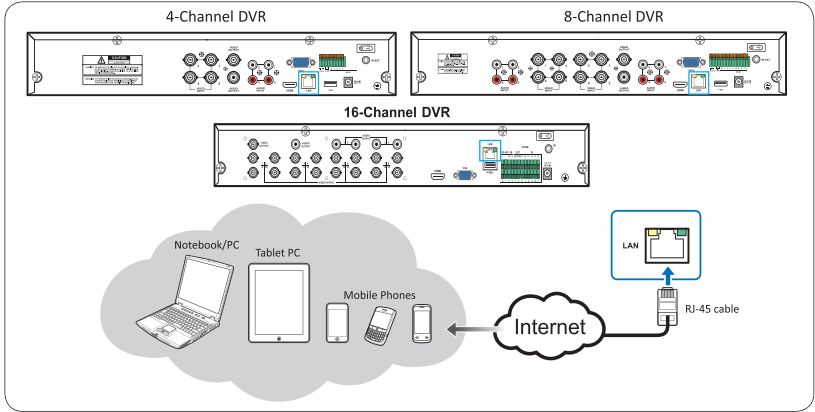

- 1 Plug one end of the RJ-45 cable to the LAN port on the back of the DVR.
- 2 Plug the other end directly into a LAN port on a router or network switch.

After connecting, configure your DVR for network communication. See "4.4 Setting the Network" on page 52 for further details.

2.9 Connecting to Other Devices

You can connect other devices such as a mouse and a USB storage drive to the DVR. Connect them to the USB port on the back or the front of the DVR.

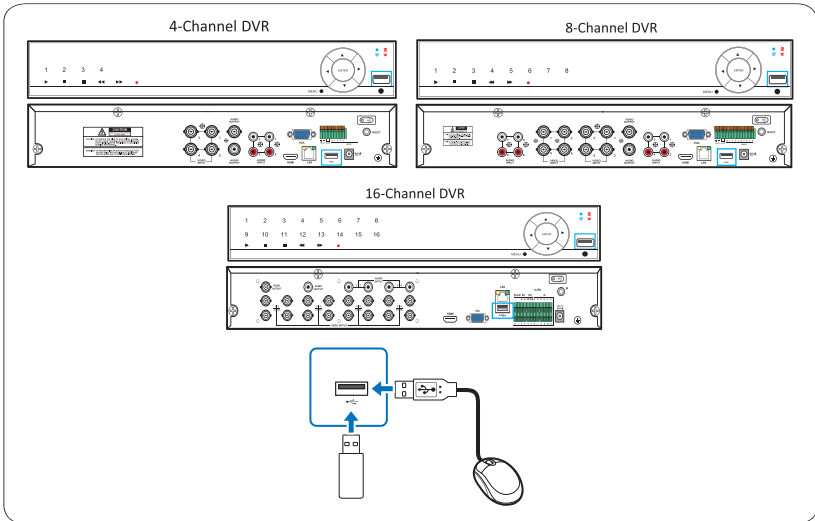

2.10 Connecting to Speakers

You can connect speakers to the DVR via RCA connection.

2.10.1 RCA Connection

Connect the speaker using RCA cable connection as shown.

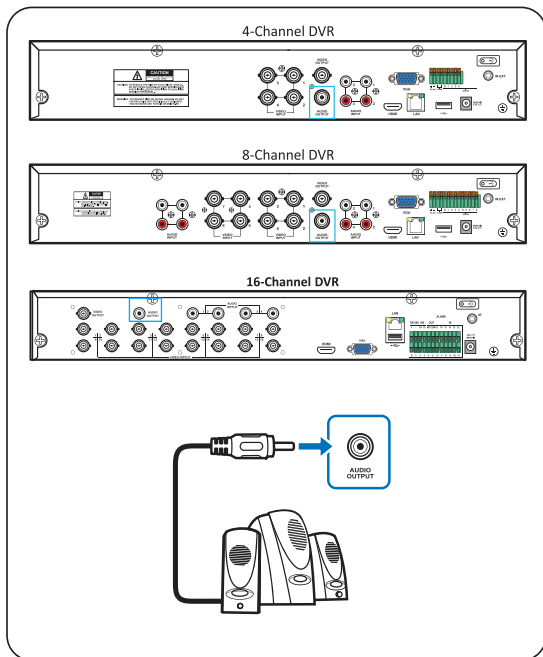

2.11 Connecting the Keyboard

2.11.1 Keyboard Connection

Connect the keyboard to DVR KB D+, D- port as shown.

Set communication protocol see "4.5.3 Serial setup on page 59" for further details.

Note:

Available in 16-channel DVR only.

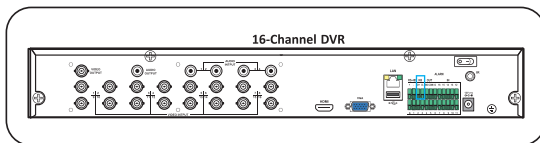

Chapter 3: Getting Started

3.1 Starting Up

Connect the power adapter to the DVR. See “2.2 Connecting the Power” on page 18 for further details.

3.2 Set Startup Wizard

1 When the Startup Wizard screen appears on the screen, click **Next Step** to continue.



To cancel the Startup Wizard, uncheck the “✓” icon on the checkbox and click **Exit** to close the current menu. The Startup Wizard will not appear after the system reboots.

2 Format the hard disk drive. See “Formatting HDD” on page 57.

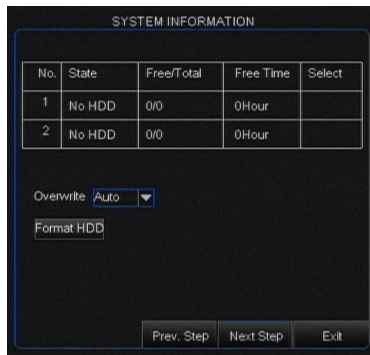

- 3 Set the recording schedule. See “4.2 Record Setup” on page 42.

SYSTEM INFORMATION

Channel: CH1

Week: Sun

00 06 12 18 23

N
M
A

N-Normal
 M-Motion
 A-Alarm
 No Record

Apply Sun To All Apply

Apply CH1 To All Apply

Prev. Step Next Step Exit

- 4 Set the date, time, OSD language, and video format settings. See “4.5.4 General Settings” on page 59.

SYSTEM INFORMATION

Date: 12/19/2013 Time: 16:43:35 Save

Date Format: MM/DD'YY

Time Format: 24Hour

DST: Setup

NTP: Setup

Language: ENGLISH

Video Format: NTSC

Prev. Step Next Step Exit

- 5 Set the network and email settings. See “4.4.1 Network Settings” on page 52 and “4.4.3 Email Settings” on page 54.

SYSTEM INFORMATION

Type: Static

Client Port: 09000

HTTP Port: 00080

IP Address: 192.168.001.100

Subnet Mask: 255.255.255.000

Gateway: 192.168.001.001

DNS 1: 192.168.001.001

DNS 2: 000.000.000.000

Auto Port Forwarding: Disable

Email DDNS Prev. Step Next Step

- 6 Click **Next Step** to save the settings.
- 7 When the initial setup process is complete, click **Close**.



Note:
To prevent the Wizard Setup screen appears every time the system reboots, unclick "Show this windows next time" to disable.

3.3 Shutting Down

To properly turn off the DVR power, do the following:

- 1 In the preview mode, right-click on the mouse to display the pop-up menu on the bottom of the screen.
- 2 Select **Main Menu > ADVANCED**, and then click **Shut Down**.

You can also access the main menu by pressing the **MENU** button on the remote control or the **Menu** key on the front panel.



- 3 A warning message appears on the screen, select **OK** to turn off the power.

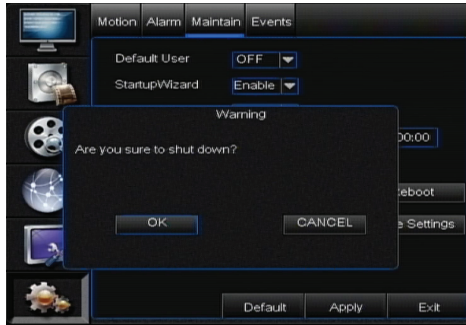

- 4 Wait until the "Now you can unplug the power!" message appears on the screen.
- 5 Turn off the power switch on the back panel of the DVR and then unplug the power cord from the power outlet.

3.4 The Main Screen

3.4.1 Screen Icons

There are four types of recording indicator on the main screen of each channel.

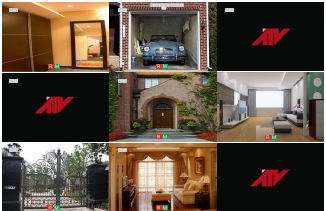

8-window display

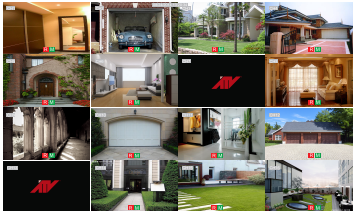

16-window display

Icon	Description
	Motion detector is activated.
	Hard disk drive memory is full. Cannot detect hard disk drive.
	Video recording is in progress.
VIDEO LOSS	

Note:

- During recording mode, [R] icon or [M] icon appears on the screen. If [M] icon is displayed on the screen, it indicates that motion detection is enabled.
- If the " " appears on the screen, check the camera connection.

3.4.2 Virtual Keyboard

The virtual keyboard automatically appears on the screen if data entry is required.



3.4.3 Locking the Screen

For system security, lock the screen to protect unauthorized OSD operation.

- 1 In the preview mode, right-click on the mouse to display the Pop-up menu.

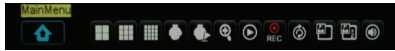

- 2 Select Main Menu > SYSTEM.

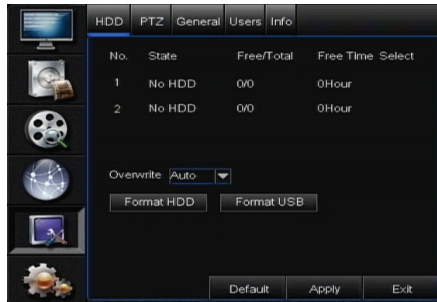

- 3 Click Users tab.

- 4 Click Edit.

- 5 Set the Password Enable to Enable.

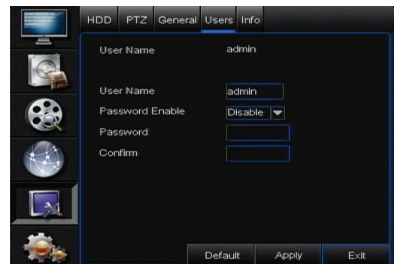
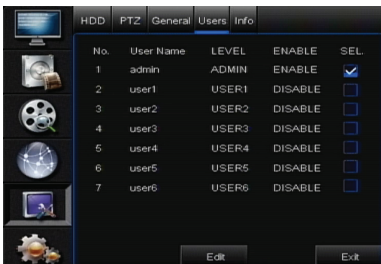

Chapter 3: Getting Started

- 6 Enter the user name and password. Then, click **Apply** (Password must be 6 characters).
- 7 Click **OK**.
- 8 To lock the screen, right-click to display the Pop-up menu and select **Lock**.

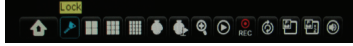

- 9 Once the lock function is activated, you need to enter the user name and password before entering the OSD menu. A virtual keyboard automatically appears on the screen.



Enter User Name

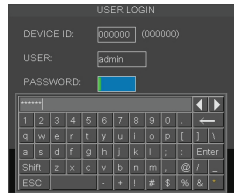

Enter Password

3.4.4 Pop-up Menu

With the Pop-up menu, you can access to the main menu and other common features. To bring up the Pop-up Menu, click on the right mouse button or press the **MENU** button on the remote control. The available Pop-up menu items vary depending on the current setting or operation.



No.	Connector	Description
1	Main Menu	Access the OSD menu and adjust the DVR settings.
2	Lock	Lock access to enter the OSD menu. You need to type the user name and password before entering the OSD menu. See page 31.
3	View 4	Switch to a 4-window display. See page 35.
4	View 9	Switch to a 9-window display (Only available for 8/16 channel version).
5	View 16	Switch to a 16-window display (Only available for 16 channel version).
6	PTZ	Use the PTZ control. See page 36.
7	Start / Stop Cruise	Start/stop cruise of the PTZ camera. See page 37.
8	Zoom	Enable zoom. See page 37.
9	Record Search	Search for recorded videos to play back. See page 45.
10	Start / Stop Record	Start/stop manual recording. See page 38.
11	Start / Stop SEQ	Start/stop SEQ of channel display. See page 35.
12	PIP 1x1	View one channel in full screen with another channel enclosed in a small window. See page 34.
13	PIP 1x2	View one channel in full screen with two other channels enclosed in small windows.
14	Audio	Turn off or turn on the audio.

3.4.5 On Screen Display (OSD) menu

You can access the OSD menu by one of the following ways:

- Right-click on the mouse and select **Main Menu**.
- Press the **MENU** button on the remote control, then select **Main Menu**
- Press the **Menu** key on the front panel, then select **Main Menu**.

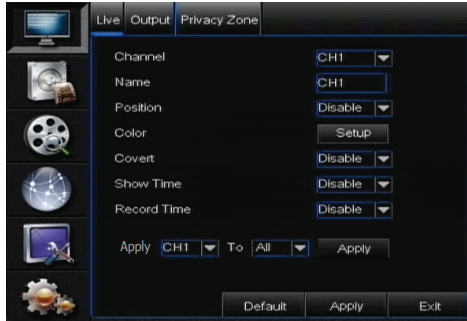

Submenu items:

DISPLAY

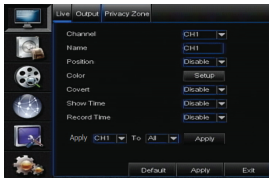

RECORD

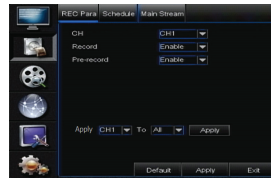

SEARCH

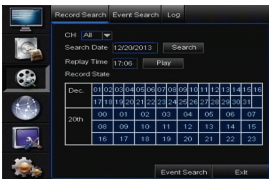

NETWORK

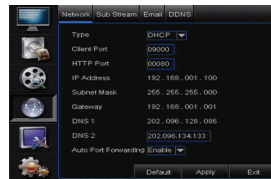

SYSTEM



ADVANCED

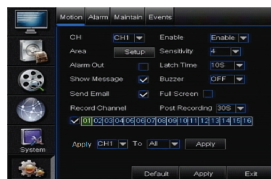

3.5 Screen Modes

3.5.1 Live View

By default, all channels are displayed on the screen in grid form.

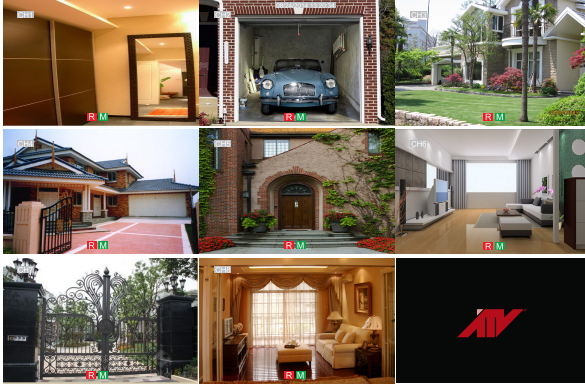

To view the live image of any channel on full screen, simply double-click the left mouse button. Double-click the left mouse button again to return to the window-display of all cameras.



3.5.2 Split Mode

You can customize the channels to be displayed separately on a 4/9/16 window on the screen.

There are 3 split mode options:

- 1 In the preview mode, right-click on the mouse to display the pop-up menu.
- 2 Select one of the following options:

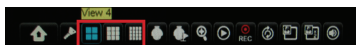

- **View 4:** Click this icon to view 4 channels at a time. Click again to view the next 4 channels and so on (Available on 4/8/16CH).
- **View 9:** Click this icon to view 9 channels at a time. Click again to view the next batch of channels (Available on 8/16CH).
- **View 16:** Click this icon to view all 16 channels at a time (Available on 16CH only).

Note:

Options to split windows may vary depending on the DVR model. Split Windows option is not available when **View Setup** is enabled (see "4.1.2 Output Settings" on page 40).

3.5.3 Picture-in-Picture (PIP) Mode

With Picture-in-Picture (PIP) mode, you can watch two more channels to be simultaneously displayed on the first channel live preview.

- 1 In the preview mode, right-click on the mouse to display the Pop-up menu.
- 2 Select one of the following options:

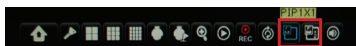

- **PIP1X1:** Click this icon to view another channel that will appear a mini-window frame on top of the main channel display.
- **PIP1X2:** Click this icon to view two more channels that will appear on two mini-window frames on top of the main channel display.

- 3 To move the mini-window around the main screen, click and drag it to a new position.

For example: PIP 1X1 mode

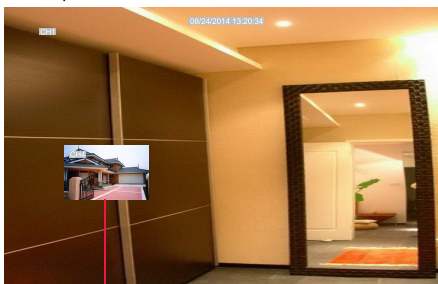

Second channel

Main channel

Chapter 3: Getting Started

3.5.4 SEQ View

With this function, the system will automatically rotate the display through all the channels and split window display.

To enable SEQ view:

- 1 In the preview mode, right-click on the mouse to display the Pop-up menu.
- 2 Select **Start SEQ**.

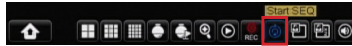

The rotating display starts. By default, each display switches at 5 seconds interval. You can change the switch SEQ time interval in **Display** menu (see "4.1.2 Output Settings" on page 40).

An example of the screen display rotation, as follows (8-channel DVR with 2 available channels):

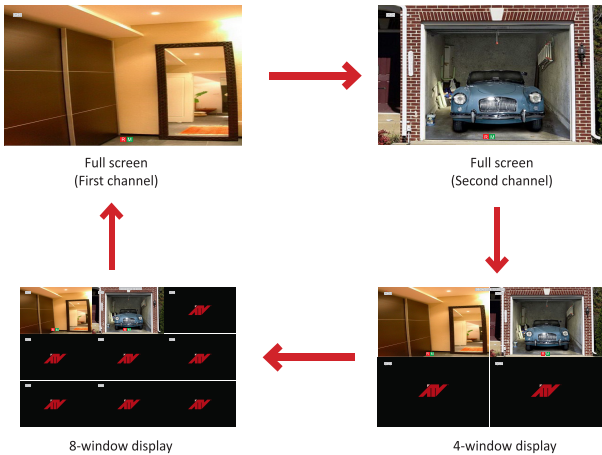

Note:

The displayed screens vary depending on the available channels.

To disable SEQ view:

- 1 Right-click on the mouse to display the Pop-up menu.
- 2 Select **Stop SEQ**.



Note:

SEQ function is not available when **View Setup** is enabled (see "4.1.2 Output Settings" on page 40).

3.6 Using PTZ Controls

If you are using a PTZ speed dome camera, you can configure the PTZ control settings.

- 1 In the preview mode, right-click on the mouse to display the Pop-up menu.
- 2 Select PTZ.

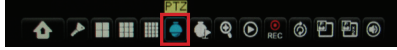

Note:

This option is not available if the PTZ camera is in Cruise mode. See “4.5.2 PTZ Setup” on page 58.

- 3 The PTZ control panel appears on the screen.



Note:

To change the PTZ settings, see “4.5.2 PTZ Setup” on page 58.

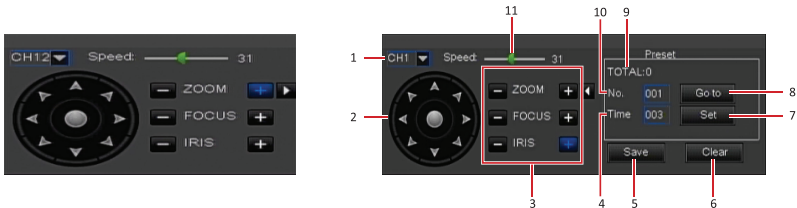

No.	Icon	Item	Function
1		Channel Select	Click to select the channel of the PTZ camera.
2		Pointer pan	Click the direction arrow to select the direction of the PTZ camera. Click the middle icon to switch to auto pan mode.
3		Zoom	Click to zoom in/out.
		Focus	Click to adjust the focus.
		Iris	Click to adjust the iris setting.
4	-	Time	Set a preset time.
5		Save	Click to save the settings and preset points.
6		Clear	Click to delete the selected preset.
7		Set Preset Point	Click to set a specific preset point on a PTZ camera. Note: You can set up to 255 preset bits for the DVR. However, the actual preset quantity varies depending on the PTZ camera performance.
		Go to Preset Point	Click to go to a specific preset point.
9	-	Total	Display the total of preset bit.
10	-	No.	Set a preset point.
11		Speed	Click to adjust the speed.

Chapter 3: Getting Started

3.6.1 Cruise Mode

Use the Start Cruise function to allow the PTZ camera to start cruising.

- 1 In the preview mode, right-click on the mouse to display the Pop-up menu.
- 2 Select **Start Cruise**.

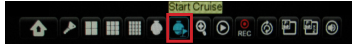

To disable cruise:

- 1 Right-click on the mouse to display the Pop-up menu.
- 2 Select **Stop Cruise**.

3.7 Zoom

With this function, you can check the details of the live display on the zoomed section.

- 1 Double-click the mouse button on a channel to view it on full screen.
- 2 Right-click on the mouse to display the Pop-up menu.
- 3 Select **Zoom**.

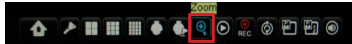

- 4 In zoom mode, click and drag the left mouse button to frame an area on the screen that you want to zoom in.
The selected location will be enlarged and displayed as full screen.

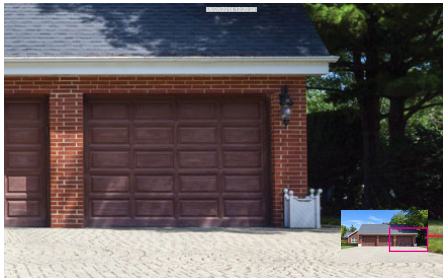

Note:

To pan another area on the screen, simply click and drag the frame on the mini-window display.

- 5 To exit zoom mode, click the right button twice. It returns to live image display mode.

3.8 Manual Recording

With this function, you can manually record the video. The system will continuously record the video until you manually stop the recording.

To enable manual recording:

- 1 In the preview mode, right-click on the mouse to display the Pop-up menu.
- 2 Select **Start Record**.



The video recording starts.

To stop the manual recording:

- 1 Right-click on the mouse to display the Pop-up menu.
- 2 Select **Stop Record**.

The video recording stops.

Remarks: If schedule recording is set, manual recording command cannot overwrite the schedule recording.

Chapter 4: Using the DVR

4.1 Setting the Display

With the **DISPLAY** menu, you can adjust the display settings such as channel type, window position, color, enable live time, set the privacy zone, and other settings. The **DISPLAY** menu is divided into three sections:

- **Live:** To configure how you want the channel to appear on the live view screen.
- **Output:** To configure the video settings.
- **Privacy Zone:** To mask areas on your camera as private zones.

4.1.1 Live Settings

1 In the preview mode, right-click on the mouse to display the Pop-up menu.

2 Select **Main Menu**  > **DISPLAY**.

3 Modify the necessary settings:



Menu Item	Description
Channel	Select the channel that you want to configure.
Name	Enter desired channel title to be displayed on the display screen.
Position	Set the title position on the screen. Example: U-L (upper left)
Color	Adjust image hue, brightness, contrast, and saturation settings. Select Setup to enter the Color submenu. Drag the slider bar to adjust the color item setting.
Covert	Select Enable to hide the channel from being displayed on the screen. Select Disable to display the channel in live view.
Show Time	Hide or display the current time while viewing the channel in live view.
Record Time	Hide or display the recording time while recording.
Apply To	Apply the current settings to all channels or one specific channel. Click the arrow to select an option and then click Apply .

4 After all settings are complete, click **Apply**.

5 When data saving is complete, click **OK**.

4.1.2 Output Settings

- 1 In the preview mode, right-click on the mouse to display the Pop-up menu.
- 2 Select **Main Menu**  > **DISPLAY**, then select the **Output** tab.
- 3 Modify the necessary settings:



Menu item	Description
Video Output	To set the video output setting of the main monitor used for live view display.
View Setup	Select Enable to enable view setup.  Note: When View Setup is enabled, Split Windows function is not available (see "3.5.2 Split Mode" on page 34).
Define SEQ setting	Click Define SEQ setting to set the order of how the channels appear.
VGA/HDMI Resolution	Select the output resolution.
Init. DEV (Initial Device)	Select where you want to display the OSD menu (BNC Video Out, HDMI, or Auto Detection).
Transparency	Slide the bar to adjust the transparency of windows.

- 4 After all settings are complete, click **Apply**.
- 5 When data saving is complete, click **OK**.

4.1.3 Privacy Zone Settings

You can mask up to 4 areas to hide it from being viewed on the screen.

- 1 In preview mode, right-click on the mouse to display the Pop-up menu.
- 2 Select **Main Menu**  > **DISPLAY**, select the **Privacy Zone** tab.



- 3 In **Channel**, select the channel that you want to set the privacy.
- 4 In **Privacy Zone**, select **Enable**.
- 5 In **Area Setup**, check the number of areas to mask. You can check **Area 1** to **Area 4** to create 4 masked areas.
- 6 Click **Setup**. The green box indicates the area for masking.

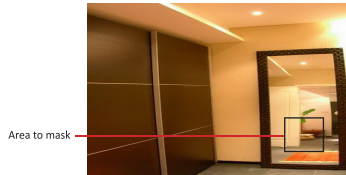

- 7 Drag the box to the area that you want to mask. You can resize the box by dragging the edges to desired size.



 **Note:**

The above illustration is an example of one checked area (Area 1). The number of green boxes depends on how many areas you checked in **Area Setup**.

- 8 Click the right mouse button untick the selected area box and click Apply to close the Select Mask screen.



- 9 After all settings are complete, click **Apply**.
 10 When data saving is complete, click **OK**.

« TIP »

To apply the privacy zone setting to other channels, select the channel(s) in **Apply To**, then click **Apply**.

4.2 Record Setup

With **RECORD** menu, you can customize the recording settings, set the recording schedule and framerate.

4.2.1 Record Parameter

- 1 In preview mode, right-click on the mouse to display the Pop-up menu.
 2 Select **Main Menu**  > **RECORD**.
 3 Modify the necessary settings.



Menu item	Description
CH	Select the channel that you want to configure.
Record	Enable/Disable record mode.
PreRecord	Enable/Disable recording prior to motion detection recording is triggered.
Apply To	Apply the current settings to all channels or one specific channel.

- 4 After all settings are complete, click **Apply**.
 5 When data saving is complete, click **OK**.

4.2.2 Schedule Recording

- 1 In preview mode, right-click on the mouse to display the Pop-up menu.
- 2 Select **Main Menu**  > **RECORD**, then select the **Schedule** tab.
- 3 On **Channel**, select the channel you want to set the schedule.
- 4 On **Week**, select the days of the week to implement the schedule.
- 5 The number labels on top of the grid indicates the time of the day. Click a box to mark the schedule.

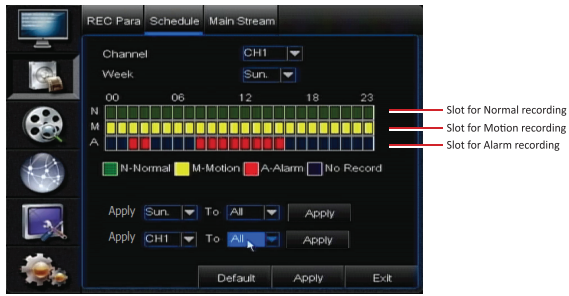

- **Normal Recording:** When the time slot is marked green, the channel performs normal recording for that time slot.
- **Motion Recording:** When the time slot is marked yellow, the channel records only when motion is detected during that time slot.
- **Alarm Recording :** When the time slot is marked red, the channel records only when the alarm is triggered during that time slot.
- **No Record:** A time slot marked blue has no recording schedule.

- 6 To remove a marked schedule, click the box again. The box turns blue.

7 After all settings are complete, click **Apply**.

« TIP »

- To apply the current settings to other days, select the day, then click **Apply**.
- To apply the current settings to other channels, select the channel, then click **Apply**.

8 When data saving is complete, click **OK**.

4.2.3 MAIN STREAM

1 In preview mode, right-click on the mouse to display the Pop-up menu.

2 Select **Main Menu**  > **RECORD**, then select the **Main stream** tab. The Framerate settings are displayed on a table.



3 On **Mode**, select the type of record mode. Options are: **D1** or **960H**.

 **Note:**

If the record mode setting is set to 960H, it is recommended to use a 600 TVL or higher resolution camera.

4 Select the channel and adjust the corresponding settings such as **Resolution**, **FPS**, and **Quality**.

 **Note:**

If the frame rate set is over the system limitation, a message is displayed on the screen.

5 Check the **Audio** box to enable audio.

6 After all settings are complete, click **Apply**.

7 When data saving is complete, click **OK**.

« TIP »

To apply the record setup setting to other channels, select the channel(s) in **Apply To** and then click **Apply**.

4.3 Searching Videos

4.3.1 Searching and Playing Videos

- 1 In preview mode, right-click on the mouse to display the Pop-up menu.
- 2 Select Main Menu  > SEARCH.
- 3 On CH, select the channel where you want to search the recorded video, or select All to search all channels.
- 4 Click the Search Date box and specify the date where you want to search the recorded video.



- 5 Click Search. The time slot of the recorded videos are marked on the Record State table. Green box means normal recording while a red box means alarm recording.

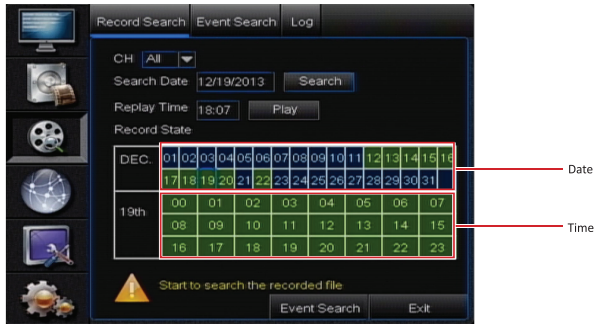

- 6 Click a time slot that you want to play.

7 Select the channel(s) to play simultaneously.



« TIP »

- To select all channels, click **All**.
- To deselect all channels, click **Clear**.

8 Click **Play** to start playback.

The playback screen varies depending on the number of channels you selected for simultaneous playback. Examples below:

Simultaneous Playback of 8 Channels

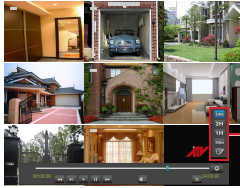

Playback
Time Frame

Simultaneous Playback of 4 Channels





Playback
Time Frame

9 To play in full screen, click a channel.





10 Click the respective button to pause, rewind, fast forward, or mute the sound. To specify the playback time frame, click the  icon and select one of the available options.

Chapter 4: Using the DVR

Options: 24 Hours, 2 Hours, 1 Hour, 30 Minutes, and Customize time frame (Click the icon ) and the icon turns blue . Click on the time bar where you desire to start, and click on the time bar again where you desire to end.)

- 11 To stop the video playback, click X.

4.3.2 Trimming Videos

- 1 Plug a USB device into the USB port of the DVR.
(Make sure the USB storage is plug to the USB port on the back of DVR).
- 2 In preview mode, right-click on the mouse to display the Pop-up menu.
- 3 Select Main Menu  > SEARCH.
- 4 On CH, select the channel where you want to search the recorded video, or select All to search all channels.
- 5 Click the Search Date box and specify the date where you want to search the recorded video.
- 6 Click Search.
- 7 Select the channel(s) to play simultaneously and click Play to start playback.
- 8 To play in full screen, click a channel.
- 9 While playing video in full screen, click the  icon to start trimming the video clip.



- 10 To stop trimming the video clip, click the  icon.

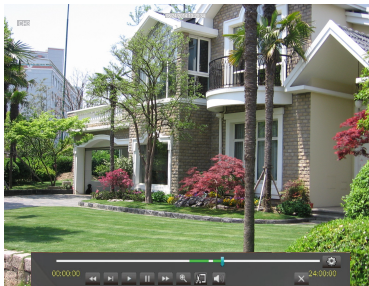

- 11 A confirmation message appears on the screen, select **Backup** to save the file.

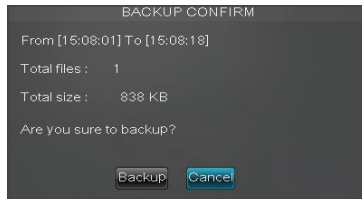

- 12 When backup is complete, click **OK** to close the Backup Status screen.



Note:

Do not remove the USB device while file transferring is in progress.

Replaying Videos by Recording Date and Time

If you are sure of the recording date and time, you can directly specify the recording date and time to replay the video without searching.

- 1 In preview mode, right-click on the mouse to display the Pop-up menu.
- 2 Select Main Menu  > SEARCH.



- 3 On **Search Date**, specify the recording date.
- 4 On **Replay Time**, specify the starting time of the recording to replay.
- 5 Click **Play**.

6 Select the channel(s) to play simultaneously.



« TIP »

- To select all channels, click **All**.
- To deselect all channels, click **Clear**.

7 Click **Play** to start playback.

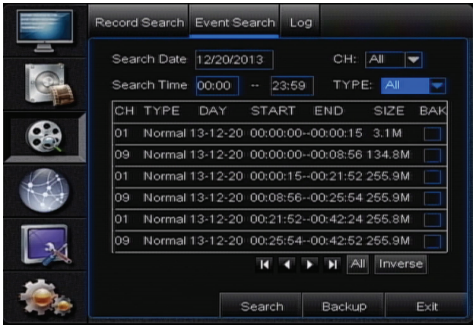

4.3.3 Searching Videos by Event

- 1 In preview mode, right-click on the mouse to display the Pop-up menu.
- 2 Select **Main Menu** > **SEARCH**, click the **Event Search** tab.
- 3 On **Search Date**, specify the recording date.
- 4 On **Search Time**, specify the starting time and the ending time to search for the event.
- 5 On **CH**, select the channel to search, or select **All** to search all channels.
- 6 On **TYPE**, select the type of recording to search. Options are: **All**, **Normal** or **Event**.



7 Click **Search**. The recordings are listed on the table.

4.3.4 Backing up Videos

- 1 Plug a USB device into the USB port of the DVR.
(Make sure the USB storage is plug to the USB port on the back fo DVR).
- 2 In preview mode, right-click on the mouse to display the Pop-up menu.
- 3 Select **Main Menu**  > **SEARCH**, select the **Event search** tab.
- 4 On **Search Date**, specify the recording date.
- 5 On **Search Time**, specify the starting time and the ending time to filter the search.
- 6 On **CH**, select the channel to search, or select **All** to search all channels.
- 7 On **TYPE**, select the type of recording. Options are: **All**, **Normal** or **Alarm**.
- 8 To browse the list, click the control buttons .
- 9 Tick the **BAK** boxes of the recordings that you want to backup.

« TIP »

- To select or unselect all check boxes, click **All**.
- To reverse the marked boxes, click **Inverse**.



- 10 Click **Backup**. The Backup Status screen appears.

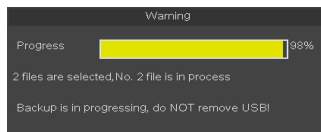

- 11 When backup is complete, click **OK** to close the Backup Status screen.

 **Note:**

Do not remove the USB device while file transferring is in progress.

4.3.5 Viewing and Exporting Log

- 1 Plug a USB device into the USB port of the DVR.
(Make sure the USB storage is plug to the USB port on the back fo DVR).
- 2 In preview mode, right-click on the mouse to display the Pop-up menu.
- 3 Select **Main Menu**  > **SEARCH**, click the **Log** tab.
- 4 On **Log Type**, select one of the log types (All/Alarm/Operation).
- 5 Specify the **Start Time** and **End Time** to filter the list.
- 6 Click **Search**. All related log files are displayed on the screen.



- 7 To browse the list, click the control buttons .
- 8 To save the log information, click **Backup**.
- 9 When saving is complete, click **OK**.

 **Note:**

- The log files are saved in “.TXT” format.
- Do not remove the USB device while file transferring is in progress.

4.4 Setting the Network

To enable remote monitoring, recording, playing, or configuring the setting via "REVO REMOTE LITE", you need to configure the network settings first. Consult your Internet Service Provider (ISP) to determine the type of network connection you are using and the required parameters to complete the setup.

4.4.1 Network Settings

You can use the Network menu to setup how the DVR connects to the network. It provides three network connection options: Static IP, DHCP, and PPPoE.

1 In preview mode, right-click on the mouse to display the Pop-up menu.

2 Select **Main Menu**  > **NETWORK**, select network tab.

3 On **Type**, select the desired network connection.

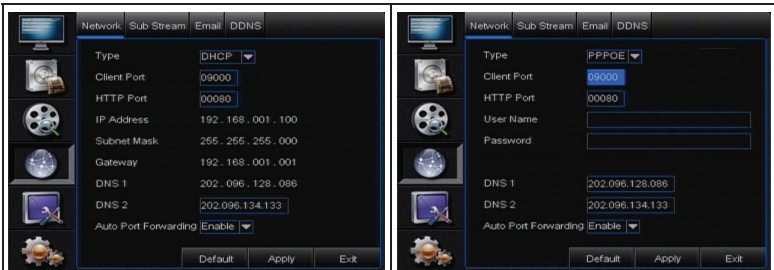

- **DHCP:** With Dynamic Host Configuration Protocol (DHCP) service, your router will automatically assign an IP address to your computer connected to the network.

- **PPPoE:** The Point-to-Point Protocol over Ethernet (PPPoE) is a network protocol for encapsulating Point-to-Point Protocol (PPP) frames inside Ethernet frames. This network protocol allows the device to be directly connected using a DSL modem.

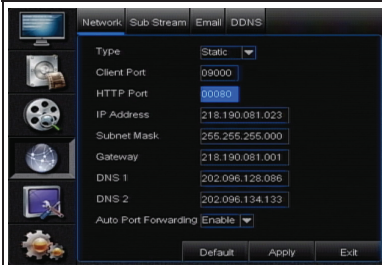

- **Static IP:** This network protocol allows you to configure the network interface using a fixed IP address.

Chapter 4: Using the DVR

4 Specify the **Client Port** and **HTTP Port** numbers.

- **Client Port:** Specify the port number that the device will use to send DVR command and video stream.
- **HTTP Port:** Specify the port number that you will use to log in to the device.

**Note:**

- Obtain these information from your network administrator or your Internet Service Provider (ISP).
- If you cannot use the either of the two default ports, 80 or 9000, the specified port may be occupied by other programs or it is being blocked by your service provider. Enter other port number.

5 Enter other parameter settings (if applicable).

- If your network connection is **Static**, specify the static IP address, Subnet Mask, Gateway, and DNS 1/DNS 2 IP addresses.
- If your network connection is **PPPoE**, enter the User Name and Password that you setup with your DSL service provider. Then, specify the DNS 1/DNS 2 IP addresses.

**Note:**

The system supports two DNS server input options: DNS Server1 for main server and DNS Server2 for sub server. Please contact your local ISP (Internet Service Provider) to obtain the correct DNS Server parameter.

6 To enable **Auto Port Forwarding (UPNP)** feature, select **Enable**.

**Note:**

Not all routers support the Auto Port Forwarding feature. If this function does not work, you must manually open the ports in your router.

7 After all settings are complete, click **Apply**.

8 When data saving is complete, click **OK**.

4.4.2 Remote Stream Setup

The Remote Stream page allows you to enable or disable video output of a particular channel if the channel is being viewed via remote access.

- 1 In preview mode, right-click on the mouse to display the Pop-up menu.
- 2 Select **Main Menu**  > **NETWORK**, select the **Sub Stream** tab. The sub stream framerate settings are displayed on a table.



- 3 Select the channel and adjust the corresponding settings such as **Video**, **FPS**, and **Bitrate**.
- 4 Check the **Audio** box to enable audio.
- 5 To apply the current settings to other channels or one specific channel. Click the arrow on **Apply** and **To** to select an option and then click **Apply**.
- 6 After all settings are complete, click **Apply**.
- 7 When data saving is complete, click **OK**.

4.4.3 Email Settings

The DVR supports sending of email notifications when events occur, such as when motion is detected or the HDD fails at the specified channel, day, and time.

 **Note:**

Be sure that the DVR network connection is properly configured before proceeding with the email setup.

To set up email, do the following:

- 1 In preview mode, right-click on the mouse to display the Pop-up menu.
- 2 Select **Main Menu**  > **NETWORK**, select the **Email** tab.
- 3 On **Email**, select **Enable**.
- 4 Click **Schedule** to implement the email schedule. For details, refer to "Email Schedule Setup" on page 55.
- 5 On **SSL**, select the **Enable** check box if your email server needs the SSL verification. Check with your email service provider for the applicable setting.

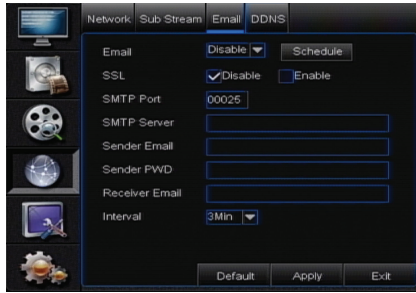

6 Enter the **SMTP port** and **SMTP Server** of the sending email server, the email address and password of the sender in **Sender** and **Sender PWD** respectively.

Note:

By default, the SMTP port is 25 for email without SSL verification. For Gmail server or for email that needs SSL verification, the SMTP port is 465, by default. Check with your ISP for the correct setting.

7 In **Receiver Email**, enter the email address where the notification email is to be sent. In **Interval**, select an email sending interval.

8 After all settings are complete, click **Apply**.

9 When data saving is complete, click **OK**.

Email Schedule Setup

Set the email notification to be sent at the specified time.

- 1 In preview mode, right-click on the mouse to display the Pop-up menu.
- 2 Select **Main Menu** > **NETWORK**, select the **Email** tab.
- 3 Click **Schedule**.
- 4 On **Channel**, select the channel you want to set the schedule.
- 5 On **Week**, select the days of the week to implement the schedule.
- 6 The number labels on top of the grid indicates the time of the day. Click a box to mark the schedule.

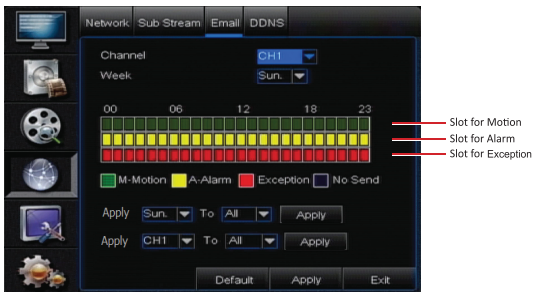

- 7 To remove a marked schedule, click the box again. The box turns blue.
- 8 After all settings are complete, click **Apply**.
 - « TIP »
 - To apply the current settings to other days, select the day, then click **Apply**.
 - To apply the current settings to other channels, select the channel, then click **Apply**.
- 9 When data saving is complete, click **OK**.

4.4.4 DDNS Settings

DDNS (Dynamic DNS) is a service that registers a domain name and the floating IP address with a DDNS server so that the domain name can be routed to the IP address even if the IP is changed in a dynamic IP system.

To use this feature, you must have a DDNS account. Consult with your Internet Service Provider for this service.

- 1 In preview mode, right-click on the mouse to display the Pop-up menu.
- 2 Select **Main Menu**  > **NETWORK**, select the **DDNS** tab.
- 3 Set **DDNS** to **Enable**.



- 4 On **Server**, select the DYNDNS server.
- 5 On **Host Name**, enter the domain name you registered on DDNS server.
- 6 Enter the DDNS **User Name** and **Password**.
- 7 After all settings are complete, click **Apply**.
- 8 When data saving is complete, click **OK**.

4.5 System Settings

4.5.1 Storage Device Setup

To ensure the hard disk drive is properly set, it is important to configure the hard disk drive settings before its initial usage. For other external hard drive and USB device, it is recommended to format those devices before their initial usage.

Setting HDD

To set up the hard disk drive, do the following:

- 1 In preview mode, right-click on the mouse to display the Pop-up menu.
- 2 Select **Main Menu**  > **SYSTEM**.



- 3 Select the hard disk drive that you want to configure. A  icon appears on the check box to indicate that the HDD has been selected (No HDD to check this operation).
- 4 On **Overwrite**, select an overwrite interval options (Disable/Auto/1 Day/3 Days/7 Days/14Days/30 Days/90 Days).

Note:

If the overwrite is set to Disable, the recording will stop once the hard disk drive is full.

- 5 After all settings are complete, click **Apply**.
- 6 When data saving is complete, click **OK**.

Formatting HDD

After a new hard disk drive is properly installed in the DVR, the system automatically detects the HDD and prompts for disk formatting.

To format the hard disk drive, do the following:

- 1 In preview mode, right-click on the mouse to display the Pop-up menu.
- 2 Select **Main Menu**  > **SYSTEM**, select HDD tab.
- 3 Select the hard disk drive that you want to format.
- 4 Click **Format HDD**.
- 5 An "All data will be deleted after formatting" warning message appears on the screen. Click **OK** to proceed.
- 6 When the formatting process is complete, click **OK**.

Formatting USB drive

To format the USB disk drive, do the following:

- 1 Plug a USB device into the USB port of the DVR.
- 2 In preview mode, right-click on the mouse to display the Pop-up menu.
- 3 Select **Main Menu**  > **SYSTEM**, select HDD tab.
- 4 Click **Format USB**.
- 5 An "All data will be deleted after formatted" warning message appears on the screen. Click **OK** to proceed.
- 6 When the formatting process is complete, click **OK**.

Note:

Do not remove the USB device while drive formatting is in progress.

4.5.2 PTZ Setup

After the PTZ speed dome is properly installed via RS-485 connection, you can customize its settings using the PTZ SETUP menu.

To set up the PTZ camera setting, do the following:

- 1 In preview mode, right-click on the mouse to display the Pop-up menu.
- 2 Select **Main Menu**  > **SYSTEM**, select the **PTZ** tab.
- 3 Select the channel which the PTZ camera is connected to.
- 4 Set the PTZ **Protocol**, **Baudrate**, **Data BIT**, **Stop BIT**, **Parity**, **Address** code.
- 5 Enable or disable **Cruise** mode.



- 6 After all settings are complete, click **Apply**.

« TIP »

To apply the current settings to other channels, select the channel(s) in **Apply To** and then click **Apply**.

- 7 When data saving is complete, click **OK**.

Note:

The PTZ camera can only be activated when a connected channel with the PTZ camera is selected.

4.5.3 Serial Setup

- 1 In preview mode, right-click on the mouse to display the Pop-up menu.
- 2 Select **Main Menu**  > **SYSTEM**, select Serial tab.
- 3 When operate DVR via keyboard, it is required to set communication protocol.
 - **Baud rate**: set baud rate of serial communication.
 - **Data bit**: set data bit of serial communication.
 - **Stop bit**: set stop bit.
 - **Parity Check**: set parity check to <None> or other.

 **Note:**
Available in 16-channel DVR only.



4.5.4 General Settings

- 1 In preview mode, right-click on the mouse to display the Pop-up menu.
- 2 Select **Main Menu**  > **SYSTEM**, select General tab.



- 3 Modify the necessary settings.

Menu item	Description
Date	Set the system date.
System Time	Set the system time.
Date Format	Select the date format.
Time Format	Select the time format.
DST	Click Setup to use Daylight Saving Time. See "Setting Daylight Saving Time" on page 60.
NTP	Click Setup to synchronize date and time with an NTP server. See "Synchronizing Time with NTP Server" on page 60 below.
Language	Select the menu language.
Video Format	Select the video format in your location: NTSC or PAL .
Menu Timeouts	Select the menu time out.

- 4 After all settings are complete, click **Apply**.
- 5 When data saving is complete, click **OK**.

Synchronizing Time with NTP Server

- 1 In preview mode, right-click on the mouse to display the Pop-up menu.
- 2 Select **Main Menu**  > **SYSTEM**, select General tab.
- 3 In **NTP**, click **Setup**.

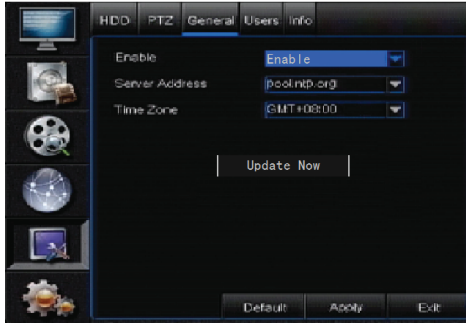

- 4 On **Server Address**, select the NTP server.
- 5 Select the **Time Zone** in your location.
- 6 On **Enable**, select **Enable**, click "Update now" to allow the system to synchronize with an NTP server.
- 7 Click **Apply** to save the settings.

Setting Daylight Saving Time

- 1 In preview mode, right-click on the mouse to display the Pop-up menu.
- 2 Select **Main Menu**  > **SYSTEM**, select General tab.
- 3 In **DST**, click **Setup**.



- 4 In **Daylight Saving Time**, select **Enable**.
- 5 In **Time Offset**, select the amount of time to offset for DST.
- 6 Select the **Daylight Saving Time Mode**.
 - **Week:** Enter the **Start Time** and **End Time** information by selecting the starting/ending month, week, day, and entering the starting/ending time.
 - **Date:** Enter the **Start Time** and **End Time** information by entering the starting/ending date and time.



- 7 After all settings are complete, click **Apply**.
- 8 When data saving is complete, click **OK**.

4.5.5 User and Password Settings

The Users page allows you to change the password and authorize users and set the access rights in using the DVR. There is one administrator account and 6 user accounts. By default, the administrator account's user name is "admin" and the password is empty. Only the administrator account is enabled by default. To grant other user to access, see "Authorizing Other Users" on page 63.

Changing the Password

To protect your account, modify your password.

- 1 In preview mode, right-click on the mouse to display the Pop-up menu.
- 2 Select **Main Menu**  > **SYSTEM**, select **Users** tab.
- 3 Click the check box of the account to change the password. A V icon appears.



- 4 Click **Edit**.



- 5 If you want to modify the user name, enter desired name in **User Name** column.
- 6 Select **Enable** in **Password Enable**.
- 7 Click the **Password** box to enter the password (see “3.4.2 Virtual Keyboard” on page 30 for details on using the virtual keyboard).

Note:

The password must be 6 numbers in length. When you are using for mobile application to view multiple channels in real-time through on your mobile device, enter the same user name and password as you specified here.

- 8 In **Confirm**, enter the password again.
- 9 After all settings are complete, click **Apply**.
- 10 When data saving is complete, click **OK**.

Remark: password must be 6 characters, can be numbers、 letters, or be a number + letters.

Configuring Other Users

Only the administrator can enable or disable a user account.

- 1 In preview mode, right-click on the mouse to display the Pop-up menu.
- 2 Select **Main Menu**  > **SYSTEM**, select the **Users** tab.
- 3 Click the check box of a user account. A icon appears.
- 4 Click **Edit**.
- 5 Enter the **User Name** (see “3.4.2 Virtual Keyboard” on page 30 for details on using the virtual keyboard).
- 6 To prompt for password, select **Enable** in **Password Status**.
- 7 Enter the password in **Password** and **Confirm**.
- 8 After all settings are complete, click **Apply**.
- 9 When data saving is complete, click **OK**.

Authorizing Other Users

Only the administrator can grant access rights to users. To set the access rights, you must login using an administrator account, and then do the following:

- 1 In preview mode, right-click on the mouse to display the Pop-up menu.
- 2 Select **Main Menu**  > **SYSTEM**, select the **Users** tab.
- 3 Click the check box of a user account. A **V** icon appears.
- 4 Click **Permission**.

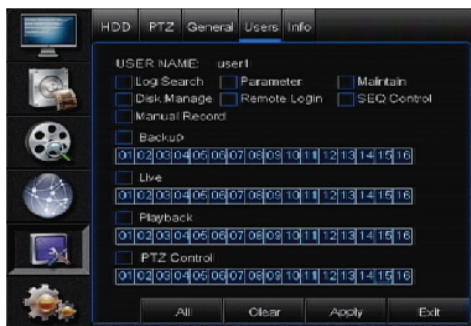

- 5 Select the check box of the corresponding menu that you want to allow the user to access.

« TIP »

Click **All** to check all options or click **Clear** to deselect all options.

- 6 After all settings are complete, click **Apply**.
- 7 When data saving is complete, click **OK**.

4.5.6 View System Info

The Version page allows you to configure the device name and ID, as well as view the MAC address, firmware version and other system information.

- 1 In preview mode, right-click on the mouse to display the Pop-up menu.
- 2 Select **Main Menu**  **> SYSTEM**, select the **Info** tab.



Menu Item	Description
Device Name	Enter desired name for the DVR. The name can be composed of alphanumeric characters. See "3.4.2 Virtual Keyboard" on page 30 for details on using the virtual keyboard.
Device ID	Enter desired ID for the DVR. The device ID, used to identify the DVR, can only be composed of numbers and cannot be the same with other IDs when multiple DVRs are connected in the same network.
Device Type	Displays the model type of the DVR.
Hardware Version	Displays the hardware version of the DVR.
Software Version	Displays the current software version of the DVR.
IE Client Version	Displays the current software version of the web client interface.
MAC Address	Displays the MAC address of the DVR. When multiple DVRs are connected to the same network, each DVR must have a unique MAC address to ensure that the DVR can connect to the network.
DVR ID	Displays the ID of the DVR. Entry the DVR ID, or scan the QR Code of the DVR, mobile client can connect to DVR directly, and remote viewing the DVR screen.

- 3 Modify the **Device Name** and **Device ID**, if necessary.
- 4 Click **Apply** to save the settings.
- 5 When data saving is complete, click **OK**.

4.5.6 P2P Connect

Note:

The MAC software does not support using User ID to login.

- 1 Make sure your DVR is connected to Internet. Refer to Network Settings on 4.4.1.
- 2 Open App Store for iOS device and Google Play for Android device.
- 3 On the search bar, enter keyword "ATV Sky Mobile" to search and download ATV Sky Mobile application.
- 4 Tap the ATV Sky Mobile  icon to open the application.
- 5 Tap "Device Manger", and then tap + to add device.

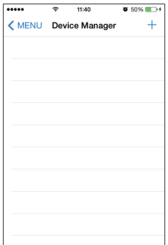
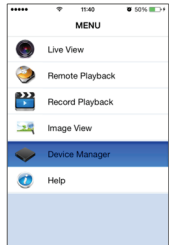

Chapter 4: Using the DVR

6 Select Device ID in the option "Login Type".





7 Tap  to scan the QR code sticker on the top of the DVR, or enter the DVR ID as shown on sticker to manually enter the QR code.

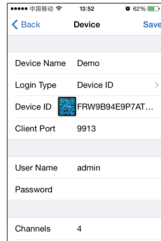

8 After input the necessary information, tab Save to add the device.

- Device Name:** Edit the name of the Device
- Client Port:** Enter the client port which you had set in the DVR Network Settings
- User Name:** Enter the DVR system user name
- Password:** Enter the DVR system password. If the password is not enable in DVR system settings, keep here blank.



9 Go back to main MENU, tab "Live View". You can add the camera one by one by tabbing +, or tab device list  to add all cameras from an existing device.

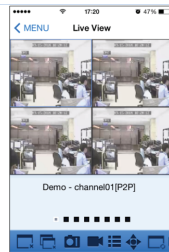
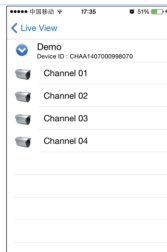
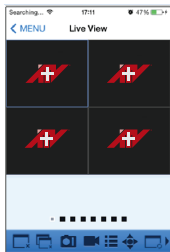

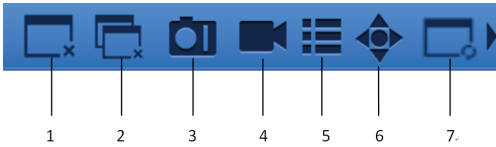

1. Open or close one camera
2. Open or close all cameras
3. Screen snapshot
4. Record video to local device
5. Device list
6. PTZ control
7. Screen splitter

4.6 Advanced Settings

The Maintain page allows you to set automatic system maintenance, load factory defaults, update the firmware settings, or reboot and power off the DVR manually.

4.6.1 Motion Detection Alarm Settings

For added security, enable the motion detection feature. When motion is detected on a selected area, the DVR issues an alarm notification. To set the motion detection alarm, do the following:

- 1 In preview mode, right-click on the mouse to display the Pop-up menu.
- 2 Select **Main Menu** > **Advanced**, select motion tab.

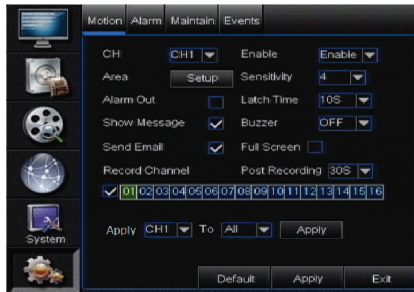

- 3 Modify the necessary settings:

Chapter 4: Using the DVR

Menu item	Description
Channel	Select the channel to set motion detection.
Enable	Select Enable to enable motion detection alarm for the channel.
Area	Click Setup to select the area for motion detection alarm. See “Set Motion Detection Area” on page 67.
Sensitivity	Select the motion detection sensitivity rate. Options are : 1~8, wherein “8” is the most sensitive and “1” is the least sensitive.
Alarm out	Check to activate alarm out function, only effective when DVR is connected to external alarm device. when motion detection is triggered, it will trigger the external alarm device as well.
Latch time	Select time interval(0/10/20/40/60s) to turn off the alarm out device.
Show Message	Check the box to display a message on screen when the alarm is triggered.
Buzzer	Set the buzzer duration when motion is detected (Off/10 S/20 S/40 S/60 S). To disable buzzer, select Off .
Send Email	Check to enable email alarm notification. If the function is enabled, the system will send the alarm images to the specified email address. See “4.4.3 Email Settings” on page 54.
Full Screen	Check the box to enable this function. If this function is enabled and the alarm is triggered, the corresponding channel will be displayed in full screen. Select the screen display duration (1 S/3 S/5 S/7 S/10 S)
Record Channel	Check the box to enable recording and then select the channels to record when the alarm is triggered.
Post Recording	Select the post-recording duration.

4 Click **Apply**.

5 When data saving is complete, click **OK**.

« **TIP** »

- To apply the current settings to other channels, select the channel, then click **Apply**.
- To revert to the default alarm settings, click **Default**.

6 When data saving is complete, click **OK**.

Set Motion Detection Area

1 In preview mode, right-click on the mouse to display the Pop-up menu.

2 Select **Main Menu**  > **Advanced**, select motion tab.

3 In the area column, click setup.

4 A grid screen with a green cursor appears. By default, the whole screen is marked for motion detection (red block). If you want to disable motion detection on an area, click the grid cursor and then drag the mouse to highlight the scope to unmark the area (transparent block) for motion detection.

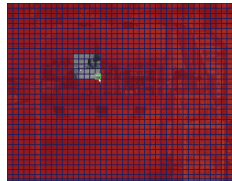
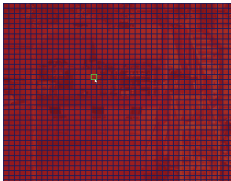

5 To close the grid screen, click the right mouse button.

6 After all settings are complete, click **Apply**.

7 When data saving is complete, click **OK**.

When motion detection is enabled on a channel, the channel screen displays the motion detection icon .

« **TIP** »

To apply the current settings to other channels, select the channel(s) in **Apply To** and then click **Apply**.

4.6.2 Other Alarm Settings

For the DVRs with a connected alarm device, do the following to set up the alarm settings:

- 1 In preview mode, right-click on the mouse to display the Pop-up menu.
- 2 Select **Main Menu**  > **ALARM**, select the **Alarm** tab.



- 3 Modify the necessary settings:

Menu item	Description
Alarm In	Select the channel that will trigger the alarm. channel available 4/8/16 channels varies on different models.
Alarm Type	Select the alarm type: NO (Normal-Open), NC (Normal-Close), or OFF .
Alarm Out	Check to activate alarm out function, only effective when DVR is connected to external alarm device. when motion detection is triggered, video loss, HDD loss or HDD is full, it will trigger the external alarm device as well.
Latch time	Select time interval(0/10/20/40/60s) to turn off the alarm out device.
Show Message	Check the box to display a message on screen when the alarm is triggered.
Buzzer	Set the buzzer duration when the alarm is triggered (Off/10 S/20 S/40 S/60 S). To disable buzzer, select Off .
Send Email	Check to enable email alarm notification. If the function is enabled, the system will send the alarm images to the specified email address. See "4.4.3 Email Settings" on page 54.
Full Screen	Check the box to enable this function. If this function is enabled and the alarm is triggered, the corresponding channel will be displayed in full screen. Select the screen display duration (1 S/3 S/5 S/7 S/10 S)
Record Channel	Check the box to enable recording and then select the channels to record when the alarm is triggered.
Post Recording	Select the post-recording duration.

- 4 Click **Apply**.

- 5 When data saving is complete, click **OK**.

« TIP »

- To apply the current settings to other channels, select the channel, then click **Apply**.
- To revert to the default alarm settings, click **Default**.

- 6 When data saving is complete, click **OK**.

4.6.3 Maintenance Settings

Manual Reboot and Power Off

To reboot or power off the DVR instantly, do the following:

- 1 In preview mode, right-click on the mouse to display the Pop-up menu.
- 2 Select **Main Menu**  > **ADVANCED**, select maintain tab.



- 3 Do one of the following:
 - Click **Shut Down** to turn off the DVR.
 - Click **Reboot** to reboot the DVR.
- 4 A message appears, click **OK** to confirm the operation.

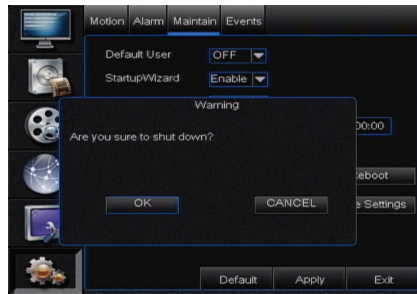

Note:

When turning off the DVR, wait for the message "Now you can unplug the power!" to appear on the screen, turn off the power switch and then unplug the power cord from the power outlet.

Disable Startup Wizard

To prevent the Wizard Setup screen appears every time the system reboots, please disable StartupWizard here.

- 1 In preview mode, right-click on the mouse to display the Pop-up menu.
- 2 Select **Main Menu > ADVANCED**
- 3 Click **Maintain** tab.
- 4 Set **StartupWizard** to **Disable**.



5 Click **Apply**.

6 Click **OK**.

Set Auto Reboot

Use this feature to automatically reboot the DVR on a specified schedule. When the DVR reboots, all settings and data are refreshed from the memory, which optimizes the DVR performance.

1 In preview mode, right-click on the mouse to display the Pop-up menu.

2 Select **Main Menu > SYSTEM > MAINTAIN**.

3 Set **Auto Reboot** to **Enable**.

4 In **Auto Reboot**, select the frequency to reboot the DVR. Options are:

- **Everyday**: Reboots the DVR on a daily basis. If this option is selected, specify the time you want to reboot the DVR.
- **Every Week**: Reboots the DVR on a weekly basis. If this option is selected, specify the day of the week and the time to reboot the DVR.



- **Every Month**: Reboots the DVR on a monthly basis. If this option is selected, specify the date (1 to 31) and the time to reboot the DVR.

Note:

The illustration above is an example of **Auto Reboot** set to **Every Week**. The available fields vary depending on the selected **Auto Maintain** and **Auto Reboot** options.

5 After all settings are complete, click **Apply**.

6 When data saving is complete, click **OK**.

« TIP »

To restore the maintenance schedule to default setting, click **Default** at the bottom of the screen.

Update System Firmware

Use this feature to update the firmware with the latest version.

1 Check for available updates and download the firmware folder named "dvrupgrade".

2 Save the "dvrupgrade" folder in a USB flash drive.

3 Insert the USB flash drive into a USB port of the DVR.

4 In preview mode, right-click on the mouse to display the Pop-up menu.

5 Select **Main Menu**  > **ADVANCED**.

6 Click **Update**.

7 Follow the instructions on the screen to complete the update.

Warning:

Do not turn off the power or unplug from the power supply while updating.

Load Default Settings

Use this feature to restore the factory default settings of the DVR.

Chapter 4: Using the DVR

- 1 In preview mode, right-click on the mouse to display the Pop-up menu.
- 2 Select **Main Menu**  > **ADVANCED**.
- 3 Click **Load Default**.
- 4 Check the check box of the settings that you want to restore.



« TIP »

- To restore all settings, click **All**.
- To deselect all checked boxes, click **Clear**.
- To cancel, click **Cancel**.

- 5 After all settings are complete, click **Apply**.
- 6 A warning message appears, click **OK** to confirm.
- 7 When data saving is complete, click **OK**.

Save System Settings

Use this feature to save the DVR current settings.

- 1 Insert the USB flash drive into a USB port of the DVR.
- 2 In preview mode, right-click on the mouse to display the Pop-up menu.
- 3 Select **Main Menu**  > **ADVANCED**.
- 4 Click **Save Settings**.
- 5 When data exporting is complete, click **OK**.

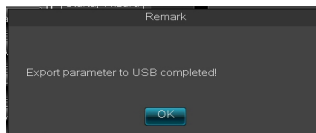

Note:

Do not remove the USB device while file transferring is in progress.

Load System Settings

Use this feature to import the settings stored in the USB flash drive.

- 1 Insert the USB flash drive into a USB port of the DVR.
- 2 In preview mode, right-click on the mouse to display the Pop-up menu.

- 3 Select **Main Menu**  > **ADVANCED**.
- 4 Click **Load Settings**.
- 5 When data importing is complete, the system will automatically reboot.

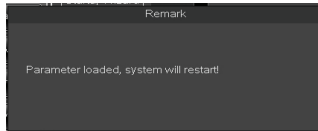

4.6.4 Events Settings

The Events page allows you to define the type of events for the DVR to issue an alarm.

- 1 In preview mode, right-click on the mouse to display the Pop-up menu.
- 2 Select **Main Menu**  > **ADVANCED**, select the **Events** tab.



- 3 Modify the necessary settings.

Menu Item	Description
Event Type	Select the event type. Options are: <ul style="list-style-type: none"> • Disk Full: When HDD is full. • Disk Error: If HDD is not detected properly. • Video Loss: If camera is not detected properly.
Enable	Select Enable to issue a notification when the event type occurs.
AlarmOut	If an alarm device is connected, check the box to make the device sound the alarm when the event occurs.
Latch Time	Select the alarm duration (10S/20S/40S/60S).
Show Message	Check the box to display a message on the screen when the event occurs.
Buzzer	Set the buzzer duration when the event occurs (Off/10 S/20 S/40 S/60 S). To disable buzzer, select Off .
Send Email	Check to enable email alarm notification. If the function is enabled, the system will send the alarm to the specified email address. See "4.4.3 Email Settings" on page 54.

- 4 After all settings are complete, click **Apply**.
- 5 A warning message appears, click **OK** to confirm.
- 6 When data saving is complete, click **OK**.

Chapter 5: Troubleshooting & FAQ

5.1 Troubleshooting

If you experience any problems in using the DVR, try the following solutions to these common problems before calling for service. If problems persist, contact the customer service in your area.

Problem	Possible Solution
The DVR does not turn on and the indicators are not lit.	<ul style="list-style-type: none"> Check if the power adapter is properly connected. Plug the power cord to another power outlet, the current outlet may be damaged. The power cord may be damaged, contact the dealer to purchase a new one.
Some channels have no video signal.	<ul style="list-style-type: none"> Check if the camera is properly connected. Check if the camera is supplied with power. Set the correct video format used in your country (NTSC/PAL). See "4.5.4 General Settings" on page 59. The camera cable may be damaged, replace with a new one.
An "H" is displayed on the screen and the DVR cannot detect the HDD.	<ul style="list-style-type: none"> Check if the HDD data and power cables are properly connected. For new HDDs, format the HDD first. See "Formatting HDD" on page 57. If all the above procedures do not work, contact Customer Service for further support.
The remote control is not working but the front panel buttons are.	<ul style="list-style-type: none"> Make sure nothing is blocking the remote control and the DVR sensor. Aim the remote control at a proper distance. Check the remote control batteries.
I cannot control the PTZ camera.	<ul style="list-style-type: none"> Make sure the protocol, baud rate, address code and other settings on the camera match the settings you have configured on the DVR. See "4.5.2 PTZ Setup" on page 58. Check if the cables are properly connected.
The buzzer keeps on sounding.	<ul style="list-style-type: none"> Check the alarm settings. Motion detection may be detected. Check the HDD capacity and the video connections, which may be triggering the alarm. Disable buzzer on the DVR settings. See "4.6.1 Motion Detection Alarm Setting" on page 66.
I cannot find the PTZ Control menu.	<ul style="list-style-type: none"> The DVR may be on Cruise mode, disable stop cruise mode first. See "3.4.4 Pop-up Menu" on page 31.
I connected an external storage device to the DVR but it cannot be recognized.	<ul style="list-style-type: none"> The external storage device may not be compatible with the DVR. Try connecting other storage devices. See the Support Manual in the enclosed CD.
I cannot access the web client.	<ul style="list-style-type: none"> Check if the network cable is properly connected to the DVR. Check if the network settings are properly configured. See "4.4 Setting the Network" on page 52. Ensure that you have Internet Explorer 6 or above.

Problem	Possible Solution
I cannot access the DVR through my mobile phone.	<ul style="list-style-type: none"> • Check if the network cable is properly connected to the DVR. • Check if the network settings are properly configured. See “4.4 Setting the Network” on page 52. • Make sure the mobile device utility is properly installed on your mobile phone. • Make sure that the mobile server port value is the same as the value set in the DVR menu.

5.2 Frequently Asked Questions

FAQ	Answer
What does “H” displayed on the screen mean?	<ul style="list-style-type: none"> • This means that the HDD cannot be detected or it is incorrectly formatted.
The DVR is hot to the touch, will this cause any problems?	<ul style="list-style-type: none"> • For sustained performance and reliability, ensure adequate ventilation around the unit and keep the DVR away from direct sunlight or heat sources.
Can the HDD be upgraded with a standard PC hard drive?	<ul style="list-style-type: none"> • Yes, a 3.5” HDD with SATA connection can be used. However, for sustained reliability, a CCTV/AV hard drive is recommended.
Is it possible to simultaneously record and playback previously recorded files?	<ul style="list-style-type: none"> • Yes, by entering the Playback menu, existing recordings can be played while recording is still in progress.
Is it possible to delete individual recordings from the unit?	<ul style="list-style-type: none"> • No, you can only delete all recordings at the same time. If you wish to delete the recordings, you need to format the HDD. <p>⚠ Warning: Formatting the HDD will erase all existing recordings! Make sure you back up the files before performing this action.</p>
Is it possible to view the system on Mac or Linux?	<ul style="list-style-type: none"> • Yes. The system can be used on a mobile phone or via Safari / Windows® Internet Explorer.

Appendix: Specifications

No. of Channel	VLD904		VLD908		VLD916	
Video						
Video Input	4 BNC Inputs		8 BNC Inputs		16 BNC Inputs	
Video Output	1 VGA, 1 BNC, 1 HDMI Outputs					
Video Output Resolution	VGA: 800x600, 1024x768, 1280x1024, 1440x900 1920x1080, HDMI: 1080p					
Audio						
Audio Input /Output	4 RCA Inputs/1 RCA Output		8RCA Inputs/1 RCA Output		4 RCA Inputs/1 RCA Output	
Live & Recording & Playback						
Video Compression	H.264					
Live Display Resolution	PAL:960×576@25fps(each ch,Frame) NTSC:960×480@30fps(each ch,Frame)					
Recording Frame Rate	DI	NTSC	120fps@CIF (360×240),	240fps@CIF (360×240),	480fps@CIF (360×480),	
			120fps@HD1 (720x240),	240fps@HD1 (720x240),	480fps@HD1 (720x480),	
			120fps@D1 (720x480)	240fps@D1 (720x480)	480fps@D1 (720x480)	
	960H	NTSC	120fps@WCIF (480×240),	240fps@WCIF (480×240),	480fps@WCIF (480×480),	
			120fps@WHD1 (960x240),	240fps@WHD1(960x240),	480fps@WHD1 (960x480),	
			120fps@WD1 (960x480)	240fps@WD1(960x480)	480fps@WD1 (960x480)	
Recording Mode	Continuous / Manual / Motion Detection / Schedule / Sensor & Alarm					
HDD Interface	1 SATA			2 SATA		
HDD Support	Up to 4TB			Up to 4TB×2		
Local Playback (Max. Channels Simultaneously)	4 Channels		8 Channels		16 Channels	
Network						
Network Interface	RJ45, 10M/100M					
Network Function	DHCP, PPPoE, Static IP, DDNS, P2P					
Mobile Surveillance	iphone, ipad, Android phones/tablet					
Alarm Inputs/Outputs	4ch sensor input 1 channel alarm out		8ch sensor input 1 channel alarm out		16ch sensor input 1 channel alarm out	
IR Port	Yes					
General						
USB	USB2.0x2 (for mouse and backup/upgrade)					
PTZ Control	RS485 Built-in, supports PELCO-P & PELCO-D					
Power Supply	12V/2A			12V/5A		
Operating Temperature (without HDD)	-10°C to 50°C (14°F to 122°F)					
Storage Temperature	-20°C to 70°C (-4°F to 158°F)					
Working Humidity	10% ~ 90%					
Dimension (W x D x H)	340 x 231.5 x 69 mm					

* Specifications are subject to change without notice.



Advanced Technology Video